

Wood Boring Tools

REVISED JAN 2026



ICS | USA

511 Main Street • Casco, WI 54205-0125 USA
(920) 837-2526 • Fax (920) 837-2530
www.icscuttingtools.com • info@icscuttingtools.com

TABLE OF CONTENTS

Auger Bits

Auger Spade	3
Dual Auger (Stud).....	19
Hand Drive Screw Eye	28
Impact Wrench	
Quick Change Hex Shank	26
Square Socket (Female)	28
SDS Shank.....	28
Ship Auger	
6" Length.....	24
8" Length.....	24
18" Length.....	24
Extended Length.....	25
Solid Center	19
Timber Auger	
30" Length.....	22
40" Length.....	22
48", 60", & 72" Lengths	23
Tri Point.....	30
Utility Pole.....	25
Wood Auger - Double Fluted	27

Bits

Curved Hole Wiring	3
Drill Saw	2
Fiberglass Hollow Core.....	32
Forstner	7
Hinge Boring.....	4
Lockhead Adjustable	2
Mortise - Bi-Directional	30
Multi-Spur Pipe - 4" Length	8
Power Pole Bits - 23" Length	25
Railroad Tie Boring Bits	29-30
Vix.....	31
Wood (Spade)	1

Countersinks

Adjustable Drill Countersinks For Wood Screws.....	20
Drill Countersinks For Wood Screws	20

Drills

Brad Point	
1/2" Shank	14
3/8" Shank	10
Straight Shank.....	10
Center Drills.....	17
Machine Drills - 1/2" Shank	12
Multi-Angle Drills.....	6
Silver & Deming Drills - 1/2" Shank - Brad Point.....	11
Drill Point Center Drills	18
Perfect Point Drills.....	15
Perfect Point Drills - 1/2" Shank	16
Screw Point Pilot Drills	8
Screw Point Pilot Auger Drills.....	27
Taper Point Drills For Wood Screws.....	20
Taper Point Drill & Countersink Combination.....	21
Threaded Shank Brad Point Dowel Drills (7/16-14).....	13
Wood (Brad Point).....	9

Cutters

Hole Cutters	
Circle	5
Double Bladed	5
Wood Plug Cutters - Claw Type.....	21

Sets

Brad Point Silver & Deming Drill - 1/2" Shank	11
Forstner Bit.....	7
Multi-Spur Pipe Bit	8
Perfect Point Wood Drill.....	15
Perfect Point Silver & Deming - 1/2" Shank.....	16
Taper Point Drill	21
Wood (Brad Point) Drill.....	9
Wood (Spade) Bit	1

Other

Boring Chucks	31
Gimlets.....	19
Power Bit Extensions.....	23
Wood Bit Extensions	3

PREMIUM TOOL STEEL
WOOD (SPADE) BITS - 6" LENGTH

ICS WIS

GENERAL PURPOSE

GROOVED POINT

QUICK CHANGE
HEX SHANK



HOLLOW
GROUND POINT

Wood Spade Bits are designed for boring holes quickly through all types of hard and soft woods, including plywood. They perform best at high RPM speeds and are easy to sharpen. Fully polished and heat treated with six ground flats on 1/4" shank. They are also known as Paddle Bits.

SIZE	ITEM NO.	PRICE	SIZE	ITEM NO.	PRICE	SIZE	ITEM NO.	PRICE	SIZE	ITEM NO.	PRICE
1/4	WBS06L016	2.26	9/16	WBS06L036	2.44	7/8	WBS06L056	2.84	1-3/8	WBS06L124	3.78
5/16	WBS06L020	2.26	5/8	WBS06L040	2.54	15/16	WBS06L060	2.90	1-1/2	WBS06L132	3.78
3/8	WBS06L024	2.26	11/16	WBS06L044	2.60	1	WBS06L100	3.18	1-3/4	WBS06L148	4.20
7/16	WBS06L028	2.42	3/4	WBS06L048	2.70	1-1/8	WBS06L108	3.78	2	WBS06L200	4.20
1/2	WBS06L032	2.42	13/16	WBS06L052	2.78	1-1/4	WBS06L116	3.78			

PREMIUM TOOL STEEL
WOOD (SPADE) BITS - 16" LENGTH

ICS WIS

GENERAL PURPOSE

GROOVED POINT

QUICK CHANGE
HEX SHANK



HOLLOW
GROUND POINT

Extra Long Wood Spade Bits are used to eliminate the need for extensions when boring deep holes or boring through thick walls. Hole in tip is used for pulling wires through wall. Fully polished and heat treated with six ground flats on 1/4" shank. They are also known as Paddle Bits.

SIZE	ITEM NO.	PRICE	SIZE	ITEM NO.	PRICE	SIZE	ITEM NO.	PRICE	SIZE	ITEM NO.	PRICE
1/4	WBS16L016	9.12	9/16	WBS16L036	10.32	13/16	WBS16L052	10.78	1-1/8	WBS16L108	11.18
5/16	WBS16L020	10.14	5/8	WBS16L040	9.50	7/8	WBS16L056	11.14	1-1/4	WBS16L116	11.18
3/8	WBS16L024	9.12	11/16	WBS16L044	10.32	15/16	WBS16L060	10.78	1-3/8	WBS16L124	11.18
7/16	WBS16L028	10.14	3/4	WBS16L048	9.50	1	WBS16L100	11.14	1-1/2	WBS16L132	11.18
1/2	WBS16L032	9.12									

WOOD (SPADE) BIT SETS

VINYL POUCH

ILLUSTRATION	CONTENTS	ITEM NO.	PRICE
<p>6 PC WOOD BIT SET</p>	<p>6" Wood Bits-Spade Type 3/8, 1/2, 5/8, 3/4, 7/8, 1"</p>	WBS-WBS06L-6	14.36

PREMIUM TOOL STEEL

LOCKHEAD ADJUSTABLE WOOD BITS - DRILL PRESS

ICS WIS

SPECIAL PURPOSE

MEDIUM SCREW POINT

STRAIGHT SHANK

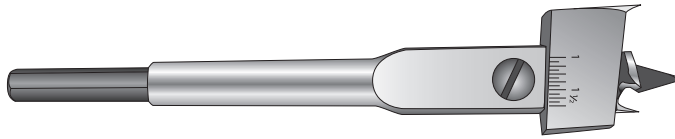

SELF-FEEDING POINT

Straight Shank Lockhead Adjustable Wood Bits are designed for drilling in wood using a portable electric drill or drill press. Blade can be adjusted to desired diameter. Does the job of up to 35 different size drills. They are also referred to as Machine Drive Expansive Wood Bits.

SIZE RANGE	SIZES	SHANK DIA.	OVERALL LENGTH	ITEM NO.	PRICE
5/8 - 1-1/2 by 8ths	19	9/32	5-1/2	LAWBDP132	13.86
7/8 - 3 by 8ths	35	11/32	6-1/2	LAWBDP300	16.42

PREMIUM TOOL STEEL

LOCKHEAD ADJUSTABLE WOOD BITS - HAND BRACE

ICS WIS

SPECIAL PURPOSE

MEDIUM SCREW POINT

STRAIGHT SHANK



SELF-FEEDING POINT

Taper Square Shank Lockhead Adjustable Wood Bits are designed for drilling in wood using a hand brace. Blade can be adjusted to desired diameter. Does the job of up to 35 different size drills. They are also referred to as Hand Drive Expansive Wood Bits.

SIZE RANGE	SIZES	SHANK DIA.	OVERALL LENGTH	ITEM NO.	PRICE
5/8 - 1-1/2 by 8ths	19	TAPER SQUARE	7-1/8	LAWBHB132	13.86
7/8 - 3 by 8ths	35	TAPER SQUARE	8-1/8	LAWBHB300	16.42

**HIGH SPEED STEEL
DRILL SAW BIT**

ICS WIS

SPECIAL PURPOSE

118° POINT

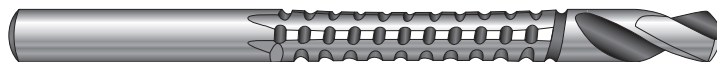

Titanium Nitride Coated High Speed Steel Drill Saw Bits are designed to drill a starting hole through wood, drywall, aluminum, plastics, brass, sheet metal etc... all in one operation. Cross milled cutting edges cut any shape in any direction the tool is moved. Drill Saw Bits are titanium nitride coated for long cutting life and for preventing resin and debris from adhering to the cutting edges.

DRILL SIZE	FLUTE LENGTH	OVERALL LENGTH	ITEM NO.	PRICE
1/8	1-1/2	2-3/8	DSBT008	2.94
1/4	2-1/4	3-3/8	DSBT016	4.20

TOOL STEEL WOOD BIT EXTENSIONS

ICS USA

GENERAL PURPOSE

PRECISION GROUND



For boring jobs requiring longer reach. Extensions can be connected to one another for extra long reach. Hex wrench included.

SIZE	LENGTH	FITS SHANK SIZE	FOLLOWS DRILL SIZE OF	ITEM NO.	PRICE
1/4	6	1/4 Hex	1/2" or larger	WBX016X06	5.08
1/4	12	1/4 Hex	1/2" or larger	WBX016X12	6.56

PREMIUM TOOL STEEL CURVED HOLE WIRING BITS

ICS USA

SPECIAL PURPOSE

SPUR POINT

1/4"
HEX SHANK



SELF-CENTERING
POINT

Curved Hole Wiring Bits are designed for boring curved (right angle) holes around corners in one continuous cut. It eliminates the need to drill two holes. Ideal for routing wiring and cable for electrical installation.

SIZE	HEX SHANK	OAL	ITEM NO.	PRICE
7/8	1/4	6-1/4	CHWB056	14.76
1-1/8	1/4	6-1/4	CHWB108	14.76
RECOMMENDED DRILLING SPEEDS				
WOODS		REVOLUTIONS PER MINUTE		
Soft Wood		850 - 1000 RPM		
Hard Wood		600 - 850 RPM		

HOW TO USE

- 1.) Drill a straight entry hole at least 1/2" into wood.
- 2.) Then steer the bit while boring through the wood toward the desired exit hole.

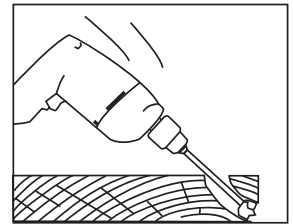

PREMIUM TOOL STEEL AUGER SPADE BITS

ICS USA

HEAVY DUTY

MEDIUM SCREW POINT

HEX SHANK



SELF-FEEDING
SCREW POINT

Auger Spade Bits are designed to cut three times faster than a spade bit and do the work of an auger bit at half the cost. Ideal for overhead work, rewiring, running pipe, conduit, and more.

SIZE	HEX SHANK	OAL	ITEM NO.	PRICE
1/2	1/4	6	ASB032	12.52
5/8	1/4	6	ASB040	13.08
3/4	5/16	6	ASB048	13.26
7/8	5/16	6	ASB056	13.58
1	5/16	6	ASB100	15.96

SIZE	HEX SHANK	OAL	ITEM NO.	PRICE
1-1/8	5/16	6	ASB108	18.24
1-1/4	5/16	6	ASB116	18.78
1-3/8	5/16	6	ASB124	19.26
1-1/2	5/16	6	ASB132	19.38

ALLOY STEEL
HINGE BORING BITS

ICS **WIS**

SPECIAL PURPOSE

DIAMOND STYLE POINT

3/8"
SHANK

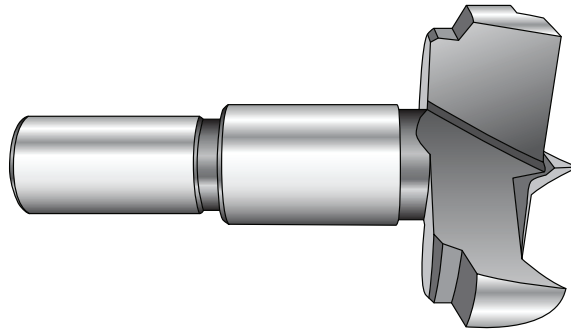

ECONOMY
TYPE

Alloy Steel Hinge Boring Bits are designed to bore clean entry holes in all types of wood for mounting European style hinges. They can be used in portable drills or drill presses and are a good economical choice for professionals and hobbyists.

SIZE	OVERALL LENGTH	ITEM NO.	PRICE
26mm	2"	HBBM26.0	3.58
30mm	2"	HBBM30.0	4.30
35mm	2"	HBBM35.0	4.72

CARBIDE TIPPED
HOLE CUTTER - DOUBLE BLADED

ICS **WIS**

HEAVY DUTY

3 FLAT
 1/2" SHANK

4 CARBIDE
 TIPPED BLADES

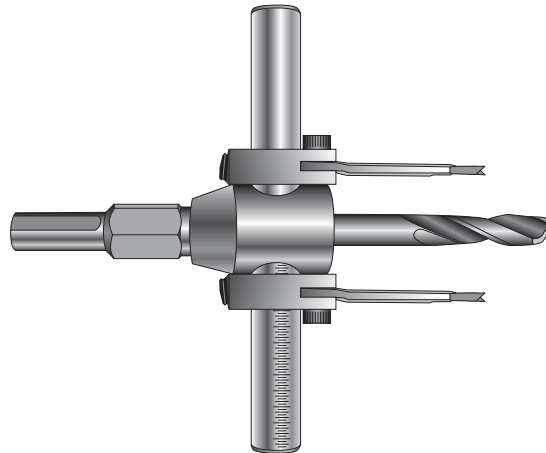

The Carbide Tipped Double Bladed Hole Cutter is designed for cutting 1-3/16" to 5-1/2" holes in sheet metal, copper, brass, aluminum, plastic, wood and composition. Maximum 1-3/4" cutting depth. Supplied with hex wrench and pilot hole drill. Measurement scale is etched on cross beam to easily set hole size. Use in any drill press or drill stand. Do not use in hand held power tools.

FOR CUTTING	CUTTING DEPTH	SHANK	ITEM NO.	PRICE
1-3/16" to 5-1/2" Holes	1-3/4	1/2	CTAHC532	30.30

HIGH SPEED STEEL
HOLE CUTTER - CIRCLE

ICS **WIS**

TREPPANNING TOOL

#2 OR #3
 MORSE TAPER SHANK

3 CAPACITY LENGTH
 TRANSVERSAL BARS

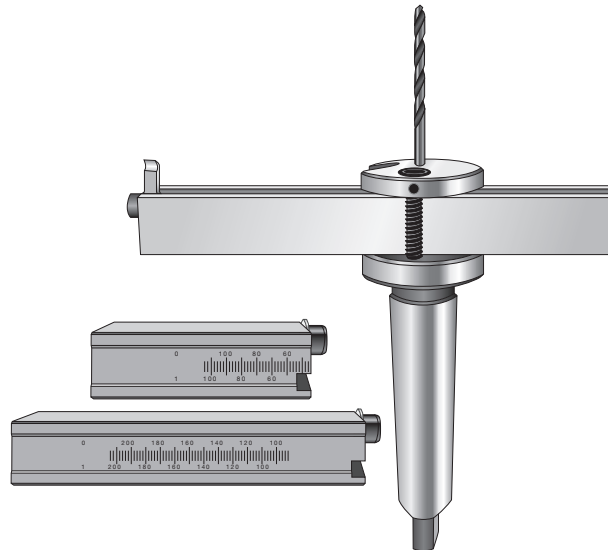

The Circular Hole Cutter is designed for cutting 1-3/16" to 11-13/16" holes in steel and non-ferrous metals. Cuts holes using the "drag-cut" principle. Very stable during machining. Faster than drilling, milling and boring. Ideal for fixed setups on product runs. Spoon shape blade allows a positive cut and is regrindable.

SIZE	CUTTING DEPTH	CUTTER SIZE	SHANK	ITEM NO.	PRICE
1-3/16 to 11-13/16 holes	1/2	5 mm	2 MT	CHC#2MT	136.50
1-3/16 to 11-13/16 holes	1/2	5 mm	3 MT	CHC#3MT	136.50

TOOL STEEL MULTI-ANGLE DRILLS

ICS WIS

SPECIAL PURPOSE

DIAMOND STYLE POINT

1/4"
HEX SHANK

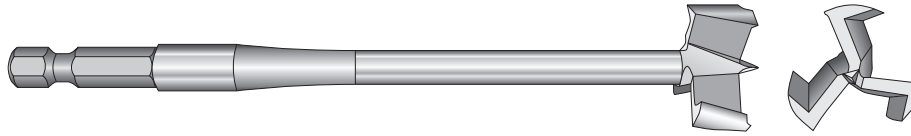

TITANIUM (TiN)
NITRIDE COATED

Multi-Angle Drills are designed with 6 cutting edges to drill forward, backward, sideways, straight, or in a curve up to 90°. Used to drill wood, composites, plaster board, plastics, etc... They drill 3X faster than spade bits and holes as smooth as forstner bits.

SIZE	OVERALL LENGTH	ITEM NO.	PRICE
1/4	5	MAD016	4.84
3/8	5	MAD024	5.56
1/2	5	MAD032	5.98
5/8	5	MAD040	6.30
3/4	5	MAD048	6.94

SIZE	OVERALL LENGTH	ITEM NO.	PRICE
13/16	5	MAD052	7.14
7/8	5	MAD056	7.78
1	5	MAD100	8.72
1-1/4	5	MAD116	11.86

TOOL STEEL MULTI-ANGLE DRILL SETS

PLASTIC INDEX

ILLUSTRATION	TYPE OF DRILL INDEX	ITEM NO.	PRICE
	4 pc Set (3/8, 1/2, 3/4, 1")	DS-MAD-4	31.50
	7 pc Set (3/8, 1/2, 5/8, 3/4, 7/8, 1", 1-1/4)	DS-MAD-7	58.80
	9 pc Set (1/4, 3/8, 1/2, 5/8, 3/4, 13/16, 7/8, 1", 1-1/4)	DS-MAD-9	88.20

5 USES IN 1 TOOL

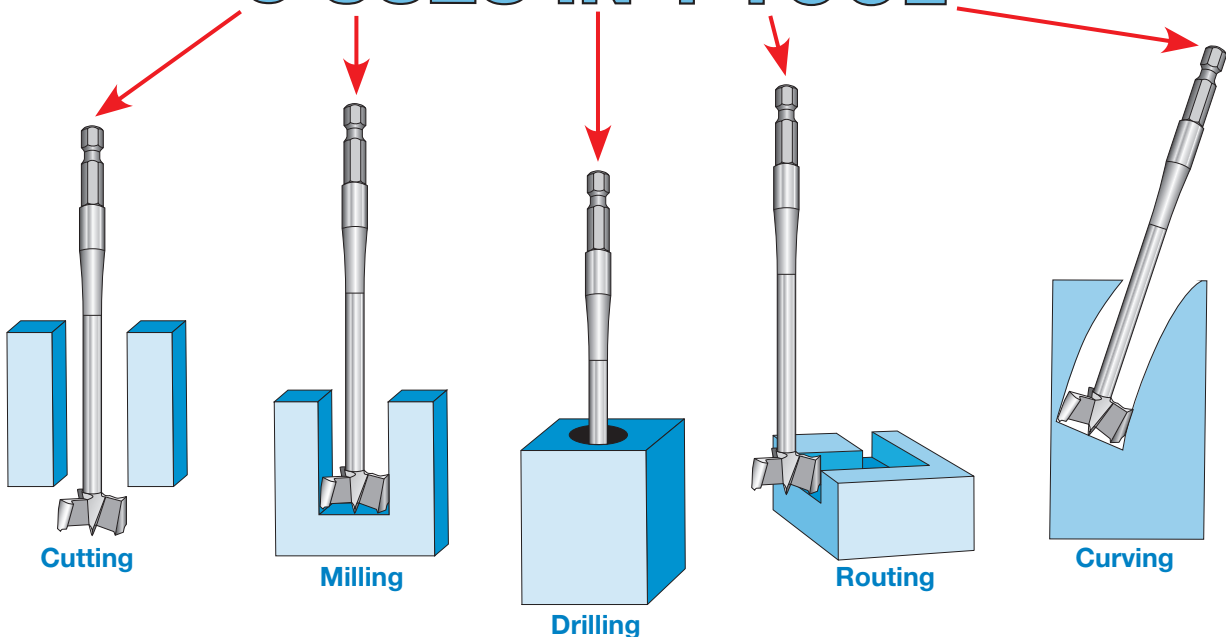

TOOL STEEL FORSTNER BITS

ICS WIS

SPECIAL PURPOSE

DIAMOND STYLE POINT

FRACTIONAL
SIZES



METRIC EUROPEAN
HINGE SIZES

Forstner bits are designed for intricate woodworking. They are used to drill flat bottom or through holes. Can bore any arc of a circle. Bit is guided by circular rim instead of center. Will cut satin smooth without deflection by grain or knots. Forstner bits are available machine ground to size from High Carbon Steel stock. Sizes 2-1/4" and over have multi-spur cutting edges. Forstner Bits are also known as Forstner Flange Bits or Webfoot Augers.

SIZE	OVERALL LENGTH	SHANK	ITEM NO.	PRICE
1/4	4	3/8	FB016	5.66
5/16	4	3/8	FB020	6.14
3/8	4	3/8	FB024	6.60
7/16	4	3/8	FB028	7.06
1/2	4	3/8	FB032	7.54
9/16	4	3/8	FB036	7.78
5/8	4	3/8	FB040	8.00
11/16	4	3/8	FB044	8.96
3/4	4	3/8	FB048	9.42
13/16	4	3/8	FB052	10.12
7/8	4	3/8	FB056	10.36
15/16	4	3/8	FB060	11.08
1	4	3/8	FB100	11.30
1-1/8	4	3/8	FB108	13.20
1-1/4	4	3/8	FB116	14.90
1-5/16	4	3/8	FB120	16.96
1-3/8	4	3/8	FB124	16.96
1-1/2	4	3/8	FB132	18.82
1-9/16	4	3/8	FB136	19.76
1-5/8	4	3/8	FB140	20.72
1-3/4	3-1/2	3/8	FB148	22.60
1-7/8	3-1/2	3/8	FB156	24.46

SIZE	OVERALL LENGTH	SHANK	ITEM NO.	PRICE
1-15/16	3-1/2	3/8	FB160	25.42
2	3-1/2	3/8	FB200	26.36
2-1/8	4	3/8	FB208	28.22
2-1/4	6	1/2	FB216	32.94
2-3/8	6	1/2	FB224	35.28
2-1/2	6	1/2	FB232	37.64
2-5/8	6	1/2	FB240	39.98
2-3/4	6	1/2	FB248	42.34
2-7/8	6	1/2	FB256	44.70
3	6	1/2	FB300	47.04
3-1/8	6	1/2	FB308	51.74
3-1/4	6	1/2	FB316	55.82
3-1/2	6	1/2	FB332	61.16
3-9/16	6	1/2	FB336	64.68
3-5/8	6	1/2	FB340	67.04
3-11/16	6	1/2	FB344	72.28
3-3/4	6	1/2	FB348	79.74
3-7/8	6	1/2	FB356	95.52
METRIC EUROPEAN HINGE SIZES				
26mm	4	3/8	FBM26.0	12.54
35mm	4	3/8	FBM35.0	17.42

TOOL STEEL FORSTNER BIT SETS

PLASTIC CASE

DESCRIPTION	CONTENTS	ITEM NO.	PRICE
 <p>8 PC FORSTNER BIT SET</p>	2-1/4 to 3-1/8 by 8ths	WBS-FB-8	280.88
5 PC FORSTNER BIT SET (NOT ILLUSTRATED)	3/4, 7/8, 1, 1-1/4, 1-5/8	WBS-FB-5	50.40
7 PC FORSTNER BIT SET (NOT ILLUSTRATED)	1/4 to 1" by 8ths	WBS-FB-7	47.26
16 PC FORSTNER BIT SET (NOT ILLUSTRATED)	1/4 to 2-1/8 by 8ths	WBS-FB-16	115.50
24 PC FORSTNER BIT SET (NOT ILLUSTRATED)	1/4 to 3-1/8 by 8ths	WBS-FB-24	252.28

TOOL STEEL MULTI-SPUR PIPE BITS - 4" LENGTH

ICS WIS

SPECIAL PURPOSE

MEDIUM SCREW POINT

7/16" SHANK
THREE FLATS

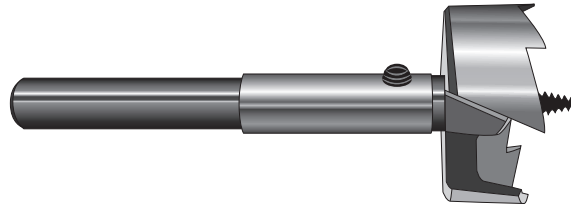

SELF-FEEDING
SCREW POINT

Multi-Spur Pipe Bits are made of special tool steel. Beveled saw teeth allow smooth boring of holes. Inside cutter pushes chips to rear of bit, allowing deep holes to be bored without clogging. Ideal for plumbing and electrical work. They are sometimes referred to as Self-Feed Bits or Saw Tooth Bits. Replacement pilot drills listed below.

SIZE	APPLICATIONS	ITEM NO.	PRICE
1	-	MSPB100	26.00
1-1/8	3/4" Pipe Entrance	MSPB108	26.00
1-1/4	-	MSPB116	26.00
1-3/8	1" Pipe Entrance	MSPB124	27.64
1-1/2	1-3/8" Tubing	MSPB132	27.64
1-3/4	1-1/4" Pipe Entrance	MSPB148	29.96
2	1-1/2" Pipe Entrance	MSPB200	30.46
2-1/8	Door Locks	MSPB208	33.92
2-1/4	2" Tubing	MSPB216	34.66
2-9/16	2" Pipe Entrance	MSPB236	40.22
3	2-1/2" Pipe Entrance	MSPB300	72.46
3-5/8	3" Pipe Entrance	MSPB340	94.50
4-5/8	4" Pipe Entrance	MSPB440	124.42

TOOL STEEL MULTI-SPUR PIPE BIT SETS

PLASTIC CASE

DESCRIPTION	CONTENTS	ITEM NO.	PRICE
4 PC MULTI-SPUR PIPE BIT SET 	1 each: 1-3/8, 1-1/2, 2-1/8, 2-9/16 Multi-Spur Pipe Bits	WBS-MSPB-4	119.70
8 PC MULTI-SPUR PIPE BIT SET (Not Illustrated)	1 each: 1, 1-1/8, 1-1/4, 1-3/8, 1-1/2, 1-3/4, 2, 2-1/8 Multi-Spur Pipe Bits	WBS-MSPB-8	241.50

SCREW POINT PILOT DRILLS



Replacement Screw Point Pilot Drills for Multi-Spur Pipe Bits.

SIZE	FITS	STYLE	ITEM NO.	PRICE
3/16	1-3/8 - 1-1/2	Double End	SPPD132	5.30
1/4	1-3/4 - 2-9/16	Double End	SPPD236	5.30
3/8	3-5/8	Single End	SPPD340	5.30

**CHROME VANADIUM
WOOD (BRAD POINT) DRILLS**

ICS WIS

SPECIAL PURPOSE

BRAD POINT



Brad Point Drills are designed to drill smooth, accurate holes in wood with minimum tear-out. Center spur point holds drill on target and prevents walking when two cutting spurs make contact with a surface, so even overlapping holes can be drilled. Drills are made of chrome vanadium steel and will stay sharp much longer than high carbon tool steels. Brad Point Drills Are also known as Dowelling Bits or Lip and Spur Drill Bits.

OVERALL			ITEM	
SIZE	LENGTH	SHANK	NO.	PRICE
1/8	2-3/4	1/8	WDBP008	2.06
5/32	3	5/32	WDBP010	2.26
3/16	3-3/8	3/16	WDBP012	2.28
1/4	4	1/4	WDBP016	2.48
5/16	4-1/8	5/16	WDBP020	3.12
3/8	4-3/8	3/8	WDBP024	3.54

OVERALL			ITEM	
SIZE	LENGTH	SHANK	NO.	PRICE
7/16	5-7/8	3/8	WDBP028	5.02
1/2	6-3/4	3/8	WDBP032	6.46
5/8	7	3/8	WDBP040	9.32
3/4	7-7/8	3/8	WDBP048	13.70
7/8	7-7/8	3/8	WDBP056	18.80
1	7-7/8	3/8	WDBP100	25.36

**CHROME VANADIUM
WOOD (BRAD POINT) DRILLS - 12" LENGTH**

ICS WIS

SPECIAL PURPOSE

BRAD POINT



Extra Long Brad Point Drills are used to eliminate the need for extensions when drilling deep holes or where longer reach is needed.

FLUTE			ITEM	
SIZE	LENGTH	SHANK	NO.	PRICE
1/8	1-1/2	1/8	WDBP12L008	5.20
5/32	1-1/2	5/32	WDBP12L010	5.62
3/16	1-7/8	3/16	WDBP12L012	6.60
1/4	2-1/2	1/4	WDBP12L016	7.60

FLUTE			ITEM	
SIZE	LENGTH	SHANK	NO.	PRICE
5/16	2-1/2	5/16	WDBP12L020	10.00
3/8	2-3/4	3/8	WDBP12L024	11.72
7/16	3-1/2	3/8	WDBP12L028	17.06
1/2	3-3/4	3/8	WDBP12L032	21.16

WOOD (BRAD POINT) DRILLS SETS

SPECIAL PURPOSE

DESCRIPTION	TYPE OF DRILL/INDEX	ITEM NO.	PRICE
7 PC DRILL SET  Sizes - 1/8 to 1/2 by 16ths	Wood (Brad Point) Drills	DS-WDBP-7	35.16
	Carbide Tipped Wood (Brad Point) Drills	DS-CTWDBP-7	55.42

HIGH SPEED STEEL BRAD POINT DRILLS

ICS USA

HEAVY DUTY

BRAD POINT



High Speed Steel Brad Point Drills are designed to drill smooth, accurate holes in wood with minimum tear-out. Center spur point holds drill on target and prevents walking when two cutting spurs make contact with a surface, so even overlapping holes can be drilled. Drills are made of high speed steel and will stay sharp much longer than high carbon tool steels. Brad Point Drills Are also known as Dowelling Bits or Lip and Spur Drill Bits.

SIZE	OVERALL LENGTH	SHANK	ITEM NO.	PRICE
1/8	2-3/4	1/8	BPD008	4.52
9/64	2-7/8	9/64	BPD009	4.72
5/32	3-1/8	5/32	BPD010	4.84
11/64	3-1/4	11/64	BPD011	4.94
3/16	3-1/2	3/16	BPD012	5.14
13/64	3-5/8	13/64	BPD013	5.14
7/32	3-3/4	7/32	BPD014	5.26
15/32	3-7/8	15/32	BPD015	5.46
1/4	4	1/4	BPD016	6.20
17/64	4-1/8	17/64	BPD017	7.36
9/32	4-1/4	9/32	BPD018	7.78
19/64	4-3/8	19/64	BPD019	8.20

SIZE	OVERALL LENGTH	SHANK	ITEM NO.	PRICE
5/16	4-1/2	5/16	BPD020	8.62
11/32	4-3/4	11/32	BPD022	9.98
3/8	5	3/8	BPD024	11.56
13/32	5-1/4	3/8	BPD026	13.24
7/16	5-1/2	3/8	BPD028	14.92
15/32	6	3/8	BPD030	15.76
1/2	6	3/8	BPD032	18.90
9/16	6	1/2	BPD036	23.00
5/8	6	1/2	BPD040	25.72
3/4	6	1/2	BPD048	35.42
7/8	6	1/2	BPD056	39.94
1	6	1/2	BPD100	-

CARBIDE TIPPED BRAD POINT DRILLS - 3/8" SHANK

ICS WIS

SPECIAL PURPOSE

SPUR BRAD POINT

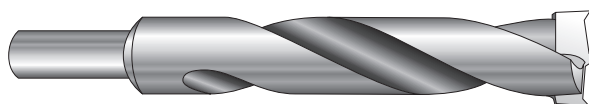
STRAIGHT
3/8" SHANKRIGHT HAND
CUT

3/8" Shank Carbide Tipped Brad Point Drills are designed for drilling any type of wood, hard fiber plates, plastic materials, laminated products, chip core, and in any wood product containing glue. They can also be used for drilling fine grain hardwoods such as maple and pecan. These are industrial grade drills that stay sharp 10 to 20 times longer than high speed steel drills. They can be resharpened with diamond needle files.

3/8" Shank • 4" Flute Length • 5-1/2" Overall Length

SIZE	SHANK DIMENSIONS	FLUTE LENGTH	OVERALL LENGTH	ITEM NO.	PRICE
3/8	3/8 x 1-1/2	4	5-1/2	CTBPD05L024TS	34.08
7/16	3/8 x 1-1/2	4	5-1/2	CTBPD05L028TS	34.96
1/2	3/8 x 1-1/2	4	5-1/2	CTBPD05L032TS	39.94
9/16	3/8 x 1-1/2	4	5-1/2	CTBPD05L036TS	45.04
5/8	3/8 x 1-1/2	4	5-1/2	CTBPD05L040TS	54.96
3/4	3/8 x 1-1/2	4	5-1/2	CTBPD05L048TS	64.54

HIGH SPEED STEEL

BRAD POINT SILVER & DEMING DRILLS - 1/2" SHANK

ICS WIS

SPECIAL PURPOSE

BRAD POINT

1/2"
ROUND SHANK



3" FLUTE LENGTH
6" OVERALL LENGTH

1/2" Shank High Speed Steel Brad Point Silver & Deming Drills with are designed to drill smooth, accurate holes in wood with minimum tear-out. Center spur point holds drill on target and prevents walking when two cutting spurs make contact with surface so even overlapping holes can be drilled. Drills are made of high speed steel and will stay sharp much longer than high carbon tool steels. Brad Point Drills are also known as Dowelling Bits or Spur Drill Bits.

Fractional Sizes (Reduced Shank) 17/32 to 1-1/2" Dia.

SIZE	FLUTE LENGTH	OVERALL LENGTH	ITEM NO.	PRICE
17/32	3	6	BPSND034	22.24
9/16	3	6	BPSND036	23.00
19/32	3	6	BPSND038	24.68
5/8	3	6	BPSND040	25.72
21/32	3	6	BPSND042	27.30
11/16	3	6	BPSND044	28.36
23/32	3	6	BPSND046	28.98
3/4	3	6	BPSND048	35.42
25/32	3	6	BPSND050	37.76
13/16	3	6	BPSND052	38.54
7/8	3	6	BPSND056	39.94

SIZE	FLUTE LENGTH	OVERALL LENGTH	ITEM NO.	PRICE
15/16	3	6	BPSND060	42.10
1	3	6	BPSND100	49.56
1-1/16	3	6	BPSND104	62.06
1-1/8	3	6	BPSND108	68.52
1-3/16	3	6	BPSND112	76.28
1-1/4	3	6	BPSND116	77.84
1-5/16	3	6	BPSND120	106.72
1-3/8	3	6	BPSND124	113.50
1-7/16	3	6	BPSND128	120.96
1-1/2	3	6	BPSND132	130.02

Metric Sizes (Reduced Shank) 13.00mm to 38.00mm Dia.

SIZE	FLUTE LENGTH	OVERALL LENGTH	ITEM NO.	PRICE
13.0	3	6	BPSNDM13.0	26.72
14.0	3	6	BPSNDM14.0	27.92
15.0	3	6	BPSNDM15.0	29.18
16.0	3	6	BPSNDM16.0	30.26
17.0	3	6	BPSNDM17.0	32.62
18.0	3	6	BPSNDM18.0	33.76
19.0	3	6	BPSNDM19.0	35.32
20.0	3	6	BPSNDM20.0	42.70
21.0	3	6	BPSNDM21.0	43.86
22.0	3	6	BPSNDM22.0	45.00
23.0	3	6	BPSNDM23.0	46.24

SIZE	FLUTE LENGTH	OVERALL LENGTH	ITEM NO.	PRICE
24.0	3	6	BPSNDM24.0	50.70
25.0	3	6	BPSNDM25.0	54.44
26.0	3	6	BPSNDM26.0	63.02
28.0	3	6	BPSNDM28.0	73.94
30.0	3	6	BPSNDM30.0	75.82
32.0	3	6	BPSNDM32.0	77.84
34.0	3	6	BPSNDM34.0	106.72
35.0	3	6	BPSNDM35.0	113.46
36.0	3	6	BPSNDM36.0	120.96
38.0	3	6	BPSNDM38.0	130.02

BRAD POINT SILVER & DEMING DRILL SET - 1/2" SHANK

METAL INDEX

DESCRIPTION	TYPE OF DRILL	ITEM NO.	PRICE
8 PC DRILL SET Sizes 9/16" to 1" by 16ths (Not Illustrated)	Brad Point Silver & Deming - 1/2" Shank	DS-BPSND-8	314.12

HIGH SPEED STEEL BRAD POINT MACHINE DRILLS - 1/2" SHANK

ICS WIS

HEAVY DUTY

BRAD POINT

1/2"
ROUND SHANK5", 6" and 8"
OVERALL LENGTHS

1/2" Shank High Speed Steel Brad Point Machine Drills are designed to drill smooth, accurate holes in wood with minimum tear-out. Center spur point holds drill on target and prevents walking when two cutting spurs make contact with surface, so even overlapping holes can be drilled. Drills are made of high speed steel and will stay sharp much longer than high carbon tool steels and are used in industrial applications.

DRILL DIAMETER	FLUTE LENGTH	OVERALL LENGTH	SHANK DIAMETER	ROTATION DIRECTION	ITEM NO.	PRICE
5" OVERALL LENGTH						
3/16	3	5	1/2	RIGHT	RSDBP05L012	18.90
1/4	3	5	1/2	RIGHT	RSDBP05L016	18.90
9/32	3	5	1/2	RIGHT	RSDBP05L018	18.90
5/16	3	5	1/2	RIGHT	RSDBP05L020	18.90
3/8	3	5	1/2	RIGHT	RSDBP05L024	18.90
7/16	3	5	1/2	RIGHT	RSDBP05L028	18.90
15/32	3	5	1/2	RIGHT	RSDBP05L030	18.90
1/2	3	5	1/2	RIGHT	RSDBP05L032	18.90
6" OVERALL LENGTH						
1/8	4	6	1/2	RIGHT	RSDBP06L008	18.90
3/16	4	6	1/2	RIGHT	RSDBP06L012	18.90
1/4	4	6	1/2	RIGHT	RSDBP06L016	18.90
5/16	4	6	1/2	RIGHT	RSDBP06L020	18.90
3/8	4	6	1/2	RIGHT	RSDBP06L024	18.90
7/16	4	6	1/2	RIGHT	RSDBP06L028	18.90
1/2	4	6	1/2	RIGHT	RSDBP06L032	18.90
9/16	4	6	1/2	RIGHT	RSDBP06L036	23.10
5/8	4	6	1/2	RIGHT	RSDBP06L040	25.20
11/16	4	6	1/2	RIGHT	RSDBP06L044	26.26
3/4	4	6	1/2	RIGHT	RSDBP06L048	31.50
7/8	4	6	1/2	RIGHT	RSDBP06L056	42.00
15/16	4	6	1/2	RIGHT	RSDBP06L060	48.30
1	4	6	1/2	RIGHT	RSDBP06L100	50.40
1-1/4	4	6	1/2	RIGHT	RSDBP06L116	73.66
8" OVERALL LENGTH						
7/16	6	8	1/2	RIGHT	RSDBP08L028	22.68
1/2	6	8	1/2	RIGHT	RSDBP08L032	22.68
9/16	6	8	1/2	RIGHT	RSDBP08L036	27.04
5/8	6	8	1/2	RIGHT	RSDBP08L040	31.50
11/16	6	8	1/2	RIGHT	RSDBP08L044	35.40
3/4	6	8	1/2	RIGHT	RSDBP08L048	37.60
13/16	6	8	1/2	RIGHT	RSDBP08L052	47.98
7/8	6	8	1/2	RIGHT	RSDBP08L056	49.74
15/16	6	8	1/2	RIGHT	RSDBP08L060	56.86
1	6	8	1/2	RIGHT	RSDBP08L100	58.28

THREADED SHANK BRAD POINT DOWEL DRILLS (7/16"-14)

ICS WIS

HEAVY DUTY

SPUR BRAD POINT



HIGH SPEED STEEL



CARBIDE TIPPED

High Speed Steel and Carbide Tipped Brad Point Dowel Drills with 7/16"-14 Threaded Shank are designed to be used in machines with threaded spindles. They will drill smooth, accurate holes in wood with minimum tear-out. Center spur point holds drill on target and prevents walking when two cutting spurs make contact with the surface, so even overlapping holes can be drilled. Drills are made of high speed steel and will stay sharp much longer than carbon steel drills. Carbide tipped sizes stay sharp 10 to 20 times longer. Used in industrial applications.

Right Hand Sizes 1/8" to 1" Dia.

DRILL DIAMETER	FLUTE LENGTH	OVERALL LENGTH	ROTATION DIRECTION	ITEM NO.	PRICE
1/8	3	4-1/2	RIGHT	TSDBP04L008	20.16
3/16	3	4-1/2	RIGHT	TSDBP04L012	20.16
1/4	3	4-1/2	RIGHT	TSDBP04L016	19.54
5/16	3	4-1/2	RIGHT	TSDBP04L020	19.54
3/8	3	4-1/2	RIGHT	TSDBP04L024	19.54
25/64	3	4-1/2	RIGHT	TSDBP04L025	19.54
13/32	3	4-1/2	RIGHT	TSDBP04L026	19.54
7/16	3	4-1/2	RIGHT	TSDBP04L028	19.54
1/2	3	4-1/2	RIGHT	TSDBP04L032	19.54
33/64	3	4-1/2	RIGHT	TSDBP04L033	35.02
9/16	3	4-1/2	RIGHT	TSDBP04L036	24.28
5/8	3	4-1/2	RIGHT	TSDBP04L040	27.30
3/4	3	4-1/2	RIGHT	TSDBP04L048	39.44
7/8	3	4-1/2	RIGHT	TSDBP04L056	51.04
1	3	4-1/2	RIGHT	TSDBP04L100	53.76
CARBIDE TIPPED SIZES					
1/4	3	4-1/2	RIGHT	CTTSDBP04L016	34.50
5/16	3	4-1/2	RIGHT	CTTSDBP04L020	38.24
3/8	3	4-1/2	RIGHT	CTTSDBP04L024	40.80
7/16	3	4-1/2	RIGHT	CTTSDBP04L028	45.50
1/2	3	4-1/2	RIGHT	CTTSDBP04L032	48.50
5/8	3	4-1/2	RIGHT	CTTSDBP04L040	63.20
3/4	3	4-1/2	RIGHT	CTTSDBP04L048	65.50
7/8	3	4-1/2	RIGHT	CTTSDBP04L056	72.00
1	3	4-1/2	RIGHT	CTTSDBP04L100	82.50

Left Hand Sizes 3/16" to 1" Dia.

DRILL DIAMETER	FLUTE LENGTH	OVERALL LENGTH	ROTATION DIRECTION	ITEM NO.	PRICE
3/16	3	4-1/2	LEFT	TSDBPL04L012	20.68
1/4	3	4-1/2	LEFT	TSDBPL04L016	20.06
5/16	3	4-1/2	LEFT	TSDBPL04L020	20.06
3/8	3	4-1/2	LEFT	TSDBPL04L024	20.06
7/16	3	4-1/2	LEFT	TSDBPL04L028	20.06
1/2	3	4-1/2	LEFT	TSDBPL04L032	20.06
9/16	3	4-1/2	LEFT	TSDBPL04L036	24.80
5/8	3	4-1/2	LEFT	TSDBPL04L040	27.82
3/4	3	4-1/2	LEFT	TSDBPL04L048	39.96
1	3	4-1/2	LEFT	TSDBPL04L100	54.60

CARBIDE TIPPED BRAD POINT DRILLS - 1/2" SHANK

ICS WIS

SPECIAL PURPOSE

SPUR BRAD POINT

STRAIGHT
1/2" SHANK

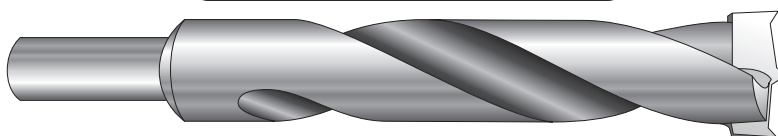

RIGHT HAND
CUT

1/2" Shank Carbide Tipped Brad Point Drills are designed for drilling any type of wood, hard fiber plates, plastic materials, laminated products, chip core, and in any wood product containing glue. They can also be used for drilling fine grain hardwoods such as maple and pecan. These are industrial grade drills that stay sharp 10 to 20 times longer than high speed steel drills. They can be resharpened with diamond needle files.

1/2" Shank • 3" Flute Length • 5" Overall Length

SIZE	SHANK DIMENSIONS	FLUTE LENGTH	OVERALL LENGTH	ITEM NO.	PRICE
1/4	1/2 x 2	3	5	CTBPD05L016	33.60
5/16	1/2 x 2	3	5	CTBPD05L020	33.60
3/8	1/2 x 2	3	5	CTBPD05L024	33.60
7/16	1/2 x 2	3	5	CTBPD05L028	34.94
1/2	1/2 x 2	3	5	CTBPD05L032	36.32
9/16	1/2 x 2	3	5	CTBPD05L036	40.96
5/8	1/2 x 2	3	5	CTBPD05L040	49.96
3/4	1/2 x 2	3	5	CTBPD05L048	58.66
7/8	1/2 x 2	3	5	CTBPD05L056	64.34
15/16	1/2 x 2	3	5	CTBPD05L060	69.62
1	1/2 x 2	3	5	CTBPD05L100	73.36

1/2" Shank • 4" Flute Length • 6" Overall Length

SIZE	SHANK DIMENSIONS	FLUTE LENGTH	OVERALL LENGTH	ITEM NO.	PRICE
1/4	1/2 x 2	4	6	CTBPD06L016	35.18
5/16	1/2 x 2	4	6	CTBPD06L020	35.18
3/8	1/2 x 2	4	6	CTBPD06L024	35.18
7/16	1/2 x 2	4	6	CTBPD06L028	36.14
1/2	1/2 x 2	4	6	CTBPD06L032	37.52
9/16	1/2 x 2	4	6	CTBPD06L036	42.00
5/8	1/2 x 2	4	6	CTBPD06L040	51.16
3/4	1/2 x 2	4	6	CTBPD06L048	60.30
7/8	1/2 x 2	4	6	CTBPD06L056	67.06
15/16	1/2 x 2	4	6	CTBPD06L060	70.50
1	1/2 x 2	4	6	CTBPD06L100	75.00
1-1/4	1/2 x 2	4	6	CTBPD06L116	90.46

1/2" Shank • 6" Flute Length • 8" Overall Length

SIZE	SHANK DIMENSIONS	FLUTE LENGTH	OVERALL LENGTH	ITEM NO.	PRICE
1/4	1/2 x 2	6	8	CTBPD08L016	36.76
5/16	1/2 x 2	6	8	CTBPD08L020	36.76
3/8	1/2 x 2	6	8	CTBPD08L024	36.76
7/16	1/2 x 2	6	8	CTBPD08L028	38.42
1/2	1/2 x 2	6	8	CTBPD08L032	39.76
5/8	1/2 x 2	6	8	CTBPD08L040	53.40
3/4	1/2 x 2	6	8	CTBPD08L048	62.56
7/8	1/2 x 2	6	8	CTBPD08L056	69.30
1	1/2 x 2	6	8	CTBPD08L100	77.26

HIGH SPEED STEEL
PERFECT POINT WOOD DRILLS

ICS WIS

SPECIAL PURPOSE

PERFECT POINT®



Perfect Point® Wood Drills are designed to drill perfectly round, clean, flat bottom holes or through holes without splintering or tearing wood grain surface. They are unique in that they do not tear wood grain when breaking through exit side of hole. They outperform and last three to five times longer than Brad Point Drills, Dowel Drills, and Forstner Bits.

Fractional Sizes (Straight/Reduced Shank) 1/8" to 1/2" Dia.

SIZE	SHANK	OVERALL LENGTH	ITEM NO.	PRICE
1/8	1/8	2-3/4	PPWD008	3.36
5/32	5/32	3-1/8	PPWD010	3.78
3/16	3/16	3-1/2	PPWD012	4.08
7/32	7/32	3-3/4	PPWD014	4.44
1/4	1/4	4	PPWD016	4.66
9/32	9/32	4-1/4	PPWD018	5.54
5/16	5/16	4-1/2	PPWD020	6.14
11/32	11/32	4-3/4	PPWD022	6.78
3/8	3/8	5	PPWD024	7.60

SIZE	SHANK	OVERALL LENGTH	ITEM NO.	PRICE
13/32	13/32	5-1/4	PPWD026	8.60
7/16	7/16	5-1/2	PPWD028	9.48
15/32	15/32	5-3/4	PPWD030	10.66
1/2	1/2	6	PPWD032	11.56
3/8" SHANK				
13/32	3/8	5-1/4	PPWDTS026	10.94
7/16	3/8	5-1/2	PPWDTS028	11.82
15/32	3/8	5-3/4	PPWDTS030	13.00
1/2	3/8	6	PPWDTS032	13.90

Metric Sizes (Straight/Reduced Shank) 3.0mm to 13.0mm Dia.

SIZE	SHANK	OVERALL LENGTH	ITEM NO.	PRICE
3.0	3.0	2-3/4	PPWDM03.0	3.36
4.0	4.0	3-1/8	PPWDM04.0	3.78
5.0	5.0	3-3/4	PPWDM05.0	4.08
6.0	6.0	4	PPWDM06.0	4.66
7.0	7.0	4-1/4	PPWDM07.0	5.54
8.0	8.0	4-1/2	PPWDM08.0	6.14
9.0	9.0	5	PPWDM09.0	7.60
10.0	10.0	5-1/4	PPWDM10.0	8.60

SIZE	SHANK	OVERALL LENGTH	ITEM NO.	PRICE
11.0	11.0	5-1/2	PPWDM11.0	9.48
12.0	12.0	5-3/4	PPWDM12.0	10.66
13.0	13.0	6-5/8	PPWDM13.0	11.56
3/8" SHANK				
10.0	9.50	5-1/4	PPWDMTS10.0	8.60
11.0	9.50	5-1/2	PPWDMTS11.0	9.48
12.0	9.50	5-3/4	PPWDMTS12.0	10.66
13.0	9.50	6-5/8	PPWDMTS13.0	11.56

PERFECT POINT WOOD DRILL SETS

METAL INDEX

DESCRIPTION	CONTENTS	ITEM NO.	PRICE
 <p>7 PC DRILL SET</p> <p>Sizes 1/8 to 1/2 by 16ths (Wt. 1.40 lbs.)</p>	Bright Finish Perfect Pt. Wood Drills	DS-PPWD-7	64.66
	Bright Finish Perfect Pt. Wood Drills - 3/8" Shank	DS-PPWDTS-7	69.36

HIGH SPEED STEEL

PERFECT POINT WOOD DRILLS - 1/2" SHANK

ICS WIS

SPECIAL PURPOSE

PERFECT POINT®

1/2" ROUND SHANK

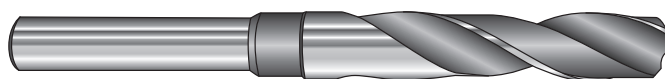

3" FLUTE LENGTH
6" OVERALL LENGTH

Perfect Point® Wood Drills with 1/2" Shank are designed to drill large, perfectly round, flat bottom holes or through holes without splintering or tearing wood grain surface. They are unique in that they do not tear wood grain when breaking through exit side of hole. They outperform and last three to five times longer than Brad Point Drills, Dowel Drills, and Forstner Bits.

Fractional Sizes (Reduced Shank) 17/32" to 1-1/2" Dia.

FLUTE SIZE	FLUTE LENGTH	OVERALL LENGTH	ITEM NO.	PRICE
17/32	3	6	PPWDRS034	20.24
9/16	3	6	PPWDRS036	21.72
19/32	3	6	PPWDRS038	24.08
5/8	3	6	PPWDRS040	24.70
21/32	3	6	PPWDRS042	25.48
11/16	3	6	PPWDRS044	26.12
23/32	3	6	PPWDRS046	27.50
3/4	3	6	PPWDRS048	35.42
25/32	3	6	PPWDRS050	37.76
13/16	3	6	PPWDRS052	38.54
7/8	3	6	PPWDRS056	39.94

FLUTE SIZE	FLUTE LENGTH	OVERALL LENGTH	ITEM NO.	PRICE
15/16	3	6	PPWDRS060	41.88
1	3	6	PPWDRS100	46.70
1-1/16	3	6	PPWDRS104	56.42
1-1/8	3	6	PPWDRS108	62.30
1-3/16	3	6	PPWDRS112	69.34
1-1/4	3	6	PPWDRS116	70.76
1-5/16	3	6	PPWDRS120	97.02
1-3/8	3	6	PPWDRS124	103.16
1-7/16	3	6	PPWDRS128	109.96
1-1/2	3	6	PPWDRS132	118.20

Metric Sizes (Reduced Shank) 13.00mm to 38.00mm Dia.

FLUTE SIZE	FLUTE LENGTH	OVERALL LENGTH	ITEM NO.	PRICE
13.0	3	6	PPWDMRS13.0	24.28
14.0	3	6	PPWDMRS14.0	25.38
15.0	3	6	PPWDMRS15.0	26.52
16.0	3	6	PPWDMRS16.0	27.52
17.0	3	6	PPWDMRS17.0	29.66
18.0	3	6	PPWDMRS18.0	30.68
19.0	3	6	PPWDMRS19.0	32.12
20.0	3	6	PPWDMRS20.0	38.82
21.0	3	6	PPWDMRS21.0	39.86
22.0	3	6	PPWDMRS22.0	40.92
23.0	3	6	PPWDMRS23.0	42.04

FLUTE SIZE	FLUTE LENGTH	OVERALL LENGTH	ITEM NO.	PRICE
24.0	3	6	PPWDMRS24.0	46.10
25.0	3	6	PPWDMRS25.0	49.48
26.0	3	6	PPWDMRS26.0	57.30
28.0	3	6	PPWDMRS28.0	67.22
30.0	3	6	PPWDMRS30.0	68.92
32.0	3	6	PPWDMRS32.0	70.76
34.0	3	6	PPWDMRS34.0	97.02
35.0	3	6	PPWDMRS35.0	103.16
36.0	3	6	PPWDMRS36.0	109.96
38.0	3	6	PPWDMRS38.0	118.20

PERFECT POINT SILVER & DEMING DRILL SET - 1/2" SHANK

METAL INDEX

DESCRIPTION	TYPE OF DRILL	ITEM NO.	PRICE
8 PC DRILL SET Sizes 9/16" to 1" by 16ths (Not Illustrated)	Dual Finish Perfect Point® Wood Drills - 1/2" Shank	DS-PPWDRS-8	307.28

HIGH SPEED STEEL BRAD POINT CENTER DRILLS

ICS WIS

SPECIAL PURPOSE

BRAD POINT



High Speed Steel Brad Point Center Drills are designed for use with all types of adjustable counterbores and countersinks when a deeper pilot hole is required. Center spur point holds drill on center and prevents walking when two cutting spurs make contact.

4-1/2" Overall Length

SIZE	FLUTE LENGTH	OVERALL LENGTH	ROTATION DIRECTION	ITEM NO.	PRICE
1/8	2-1/2	4-1/2	RIGHT	BPCD04L008	7.04
5/32	2-1/2	4-1/2	RIGHT	BPCD04L010	7.04
3/16	2-1/2	4-1/2	RIGHT	BPCD04L012	7.28
7/32	2-1/2	4-1/2	RIGHT	BPCD04L014	7.28
1/4	2-1/2	4-1/2	RIGHT	BPCD04L016	7.88
5/16	2-1/2	4-1/2	RIGHT	BPCD04L020	12.02

6" Overall Length

SIZE	FLUTE LENGTH	OVERALL LENGTH	ROTATION DIRECTION	ITEM NO.	PRICE
1/8	2-1/2	6	RIGHT	BPCD06L008	7.04
5/32	2-1/2	6	RIGHT	BPCD06L010	7.04
3/16	2-1/2	6	RIGHT	BPCD06L012	7.28
7/32	2-1/2	6	RIGHT	BPCD06L014	7.28
1/4	2-1/2	6	RIGHT	BPCD06L016	7.88
9/32	2-1/2	6	RIGHT	BPCD06L018	11.60
19/64	2-1/2	6	RIGHT	BPCD06L019	12.02
5/16	2-1/2	6	RIGHT	BPCD06L020	12.02
3/8	2-1/2	6	RIGHT	BPCD06L024	12.02

7" Overall Length

SIZE	FLUTE LENGTH	OVERALL LENGTH	ROTATION DIRECTION	ITEM NO.	PRICE
3/16	3-1/2	7	RIGHT	BPCD07L012	7.78
7/32	3-1/2	7	RIGHT	BPCD07L014	8.40
1/4	3-1/2	7	RIGHT	BPCD07L016	9.56

8" Overall Length

SIZE	FLUTE LENGTH	OVERALL LENGTH	ROTATION DIRECTION	ITEM NO.	PRICE
3/16	3-1/2	8	RIGHT	BPCD08L012	8.40
7/32	3-1/2	8	RIGHT	BPCD08L014	9.04
1/4	3-1/2	8	RIGHT	BPCD08L016	10.08

6" Overall Length - LEFT HAND

SIZE	FLUTE LENGTH	OVERALL LENGTH	ROTATION DIRECTION	ITEM NO.	PRICE
3/16	2-1/2	6	LEFT	BPCDL06L012	7.28
7/32	2-1/2	6	LEFT	BPCDL06L014	7.88

HIGH SPEED STEEL DRILL POINT CENTER DRILLS

ICS WIS

SPECIAL PURPOSE

90° POINT



High Speed Steel 90° Drill Point Center Drills in sizes 3/32" to 3/8" are designed for use with all types of adjustable counterbores and countersinks when a deeper pilot hole is required or for straight boring jobs. 90° drills on center and reduces chipping and grabbing on break through.

4-1/2" Overall Length

SIZE	FLUTE LENGTH	OVERALL LENGTH	ROTATION DIRECTION	ITEM NO.	PRICE
3/32	2-1/2	4-1/2	RIGHT	DPCD04L006	7.04
1/8	2-1/2	4-1/2	RIGHT	DPCD04L008	7.04
5/32	2-1/2	4-1/2	RIGHT	DPCD04L010	7.04
3/16	2-1/2	4-1/2	RIGHT	DPCD04L012	7.04
7/32	2-1/2	4-1/2	RIGHT	DPCD04L014	7.28
1/4	2-1/2	4-1/2	RIGHT	DPCD04L016	7.88
9/32	2-1/2	4-1/2	RIGHT	DPCD04L018	12.60
19/64	2-1/2	4-1/2	RIGHT	DPCD04L019	12.60
5/16	2-1/2	4-1/2	RIGHT	DPCD04L020	12.60
3/8	2-1/2	4-1/2	RIGHT	DPCD04L024	12.60

6" Overall Length

SIZE	FLUTE LENGTH	OVERALL LENGTH	ROTATION DIRECTION	ITEM NO.	PRICE
3/32	2-1/2	6	RIGHT	DPCD06L006	7.04
1/8	2-1/2	6	RIGHT	DPCD06L008	7.04
5/32	2-1/2	6	RIGHT	DPCD06L010	7.04
3/16	2-1/2	6	RIGHT	DPCD06L012	7.04
7/32	2-1/2	6	RIGHT	DPCD06L014	7.28
1/4	2-1/2	6	RIGHT	DPCD06L016	7.88
9/32	2-1/2	6	RIGHT	DPCD06L018	12.60
19/64	2-1/2	6	RIGHT	DPCD06L019	12.60
5/16	2-1/2	6	RIGHT	DPCD06L020	12.60
3/8	2-1/2	6	RIGHT	DPCD06L024	12.60

6" Overall Length - LEFT HAND

SIZE	FLUTE LENGTH	OVERALL LENGTH	ROTATION DIRECTION	ITEM NO.	PRICE
3/16	2-1/2	6	LEFT	DPCDL06L012	8.10

TOOL STEEL GIMLETS

ICS WIS

GENERAL PURPOSE

FAST SCREW POINT



SELF-FEEDING POINT

Quality hand tool for boring in soft or hard woods. Sharp screw tip bites into wood. (Limited supply available.)

SIZE	LENGTH	ITEM NO.	PRICE
5/64	4-1/8	GIM005	1.90
1/8	4-1/2	GIM008	2.18
5/32	4-3/4	GIM010	2.34
3/16	5	GIM012	2.62

SIZE	LENGTH	ITEM NO.	PRICE
1/4	5-3/8	GIM016	3.22
9/32	5-1/2	GIM018	3.50
5/16	5-3/4	GIM020	4.06

TOOL STEEL AUGER (SOLID CENTER) BITS

ICS WIS

GENERAL PURPOSE

MEDIUM SCREW POINT

TAPER SQUARE SHANK



SELF-FEEDING POINT

Solid Center Auger Bits are designed for use in a hand bit brace and may be used for all general purpose boring in soft or hard woods. Single flute design with double cutters, two outlining spurs, and a self-feeding medium fast pitch screw point.

SIZE	LENGTH	ITEM NO.	PRICE
1/4	8	AB016	5.26
5/16	8	AB020	5.26
3/8	8	AB024	5.64
7/16	8	AB028	5.64
1/2	8	AB032	5.64
9/16	8-1/2	AB036	5.64
5/8	8-1/2	AB040	6.52
11/16	8-1/2	AB044	6.52

SIZE	LENGTH	ITEM NO.	PRICE
3/4	9	AB048	8.40
13/16	9	AB052	8.40
7/8	9	AB056	9.20
15/16	9	AB060	9.70
1	9	AB100	9.70
1-1/8	10	AB108	15.92
1-1/4	10	AB116	15.92
1-1/2	10	AB132	17.14

PREMIUM TOOL STEEL DUAL AUGER (STUD) BITS

ICS WIS

HEAVY DUTY

FAST SCREW POINT

HEX SHANK



SELF-FEEDING POINT

Dual Auger Stud Bits are designed for use in a hand bit brace or a 3/8" or larger electric power drill and are used for fast and accurate boring in soft or hard woods. Single flute design with single cutter, an outlining spur, and a self-feeding fast pitch screw point.

SIZE	SHANK	ITEM NO.	PRICE
1/4	1/4	DAB016	7.98
5/16	5/16	DAB020	7.98
3/8	3/8	DAB024	7.98
7/16	3/8	DAB028	8.48
1/2	3/8	DAB032	8.48
9/16	3/8	DAB036	10.58
5/8	3/8	DAB040	10.58
11/16	3/8	DAB044	12.36
3/4	3/8	DAB048	12.36

SIZE	SHANK	ITEM NO.	PRICE
13/16	3/8	DAB052	14.20
7/8	3/8	DAB056	14.20
15/16	3/8	DAB060	17.60
1	3/8	DAB100	17.60
1-1/8	7/16	DAB108	19.72
1-1/4	7/16	DAB116	25.78
1-3/8	7/16	DAB124	29.60
1-1/2	7/16	DAB132	32.18

HIGH SPEED STEEL TAPER POINT DRILLS FOR WOOD SCREWS

ICS WIS

SPECIAL PURPOSE

TAPER POINT

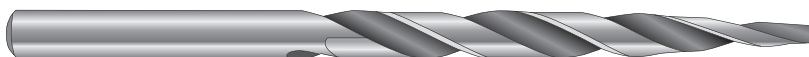

Taper Point Drills are designed to drill tapered holes in wood and plastic to match a wood screw's thread and shank in one operation. They fit most counterbores and countersinks. Shank diameter is the same as the drill size.

DRILL DIAMETER	WOOD SCREW SIZE	REGULAR LENGTH		ITEM NO.	PRICE EACH
		FLUTE LENGTH	OVERALL LENGTH		
5/64	#2	1	2	TPDRL005#02	3.26
3/32	#3	1-1/4	2-1/4	TPDRL006#03	3.28
7/64	#4	1-1/2	2-5/8	TPDRL007#04	3.30
1/8	#5	1-5/8	2-3/4	TPDRL008#05	3.58
9/64	#6	1-3/4	2-7/8	TPDRL009#06	3.82
5/32	#7	2	3-1/8	TPDRL010#07	3.82
11/64	#8	2-1/8	3-1/4	TPDRL011#08	3.96
3/16	#9	2-5/16	3-1/2	TPDRL012#09	4.10
13/64	#10	2-7/16	3-5/8	TPDRL013#10	4.36
7/32	#12	2-1/2	3-3/4	TPDRL014#12	4.62
1/4	#14	2-3/4	4	TPDRL016#14	5.14

CARBON STEEL DRILL COUNTERSINKS FOR WOOD SCREWS

ICS WIS

SPECIAL PURPOSE

82° ANGLE

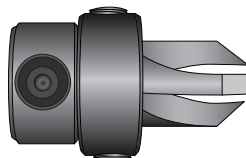

Carbon Steel Drill Countersinks are designed to cut bevels in wood and plastic for wood screw heads #5 through #14. They attach to the drill with two set screws and can be adjusted up and down the drill for any length from a #5 to a #14 wood screw. They can also be reversed on the drill and used as a drill stop. Adjustable Drill Countersinks are also known as Shell Countersinks.

DRILL HOLE	WOOD SCREW SIZE	BODY DIAMETER	OVERALL LENGTH	ITEM NO.	PRICE EACH
1/8	#5	3/8	7/8	WDCSK482-008	5.12
9/64	#6	3/8	7/8	WDCSK482-009	5.12
5/32	#7	3/8	7/8	WDCSK482-010	5.12
11/64	#8	3/8	7/8	WDCSK482-011	5.12
3/16	#9	3/8	7/8	WDCSK482-012	5.12
13/64	#10	7/16	7/8	WDCSK482-013	5.48
7/32	#12	3/8	7/8	WDCSK482-014	5.48
1/4	#14	1/2	7/8	WDCSK482-016	5.70

CARBIDE TIPPED ADJUSTABLE DRILL COUNTERSINKS FOR WOOD SCREWS

ICS WIS

SPECIAL PURPOSE

82° ANGLE

USE WITH
3/32 to 3/16
DRILL SIZES

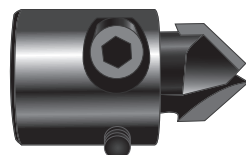

COUNTERSINKS
#4 to #10
WOOD SCREW

Carbide Tipped Adjustable Drill Countersinks are designed to cut bevels in wood and plastic for wood screw heads #4 to #10. They attach to the drill with two set screws and can be adjusted up and down the drill for any length from a #4 to a #10 wood screw. They can also be reversed on the drill and used as a drill stop. Adjustable Drill Countersinks are also known as Shell Countersinks.

DRILL SIZES	SCREW SIZES	ITEM NO.	PRICE
3/32 to 3/16	#4 to #10	CTADCSK012	15.76

HIGH SPEED STEEL

TAPER POINT DRILL & COUNTERSINK COMBINATION

ICS WIS

SPECIAL PURPOSE

3 PC SET

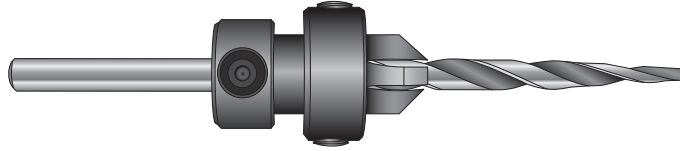

Taper Point Drill and Countersink Combination tools allow you to drill and countersink wood screw holes in one operation. A stop collar is included to control depth of hole.

DRILL DIAMETER	WOOD SCREW SIZE	REGULAR LENGTH		ITEM NO.	PRICE EACH
		FLUTE LENGTH	OVERALL LENGTH		
1/8	#5	1-5/8	2-3/4	TPDRL/CC008	9.14
9/64	#6	1-3/4	2-7/8	TPDRL/CC009	9.14
5/32	#7	2	3-1/8	TPDRL/CC010	9.14
11/64	#8	2-1/8	3-1/4	TPDRL/CC011	9.34
3/16	#9	2-5/16	3-1/2	TPDRL/CC012	9.78
13/64	#10	2-7/16	3-5/8	TPDRL/CC013	10.08
7/32	#12	2-1/2	3-3/4	TPDRL/CC014	10.30
1/4	#14	2-3/4	4	TPDRL/CC016	10.82

TAPER POINT DRILL SETS

VINYL POUCH

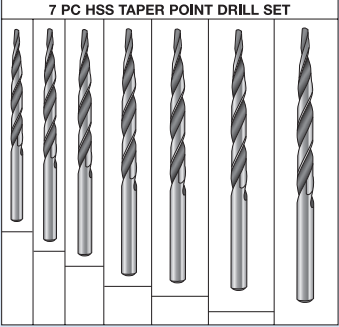
DESCRIPTION	CONTENTS	ITEM NO.	PRICE
7 PC Taper Point Drill Set 	1 each: 1/8, 9/64, 5/32, 11/64, 3/16, 7/32, 1/4 Taper Point Drills Regular Length	DS-TPDRL-7	19.42

CARBON STEEL

WOOD PLUG CUTTERS - CLAW TYPE

ICS WIS

SPECIAL PURPOSE

FOUR CUTTING BLADES

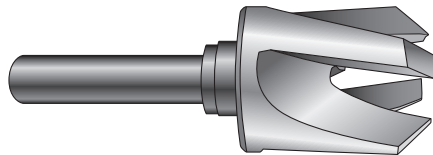

Claw Type Wood Plug Cutters are designed for cutting your own wood plugs. They cut clean and fast to make smooth chamfered plugs for easy starting in the counterbored holes. They do not eject the plug which remains in the board and can be broken out with a blade screwdriver or the board can be sawed to free the plug. Wood plugs are used to conceal screw heads in counterbored holes.

SIZE	FITS	STYLE	ITEM NO.	PRICE
1/4	1/2	3/8	WPCCT016	6.64
3/8	1/2	3/8	WPCCT024	7.94
7/16	1/2	3/8	WPCCT028	8.76
1/2	1/2	3/8	WPCCT032	9.04
5/8	5/8	3/8	WPCCT040	11.10

PREMIUM TOOL STEEL
TIMBER AUGER BITS - 30" LENGTH

ICS WIS

HEAVY DUTY

MEDIUM SCREW POINT

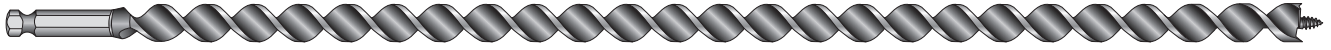

7/16"
QUICK CHANGE
HEX SHANK

30" Overall Length x 26" Double Flute Length

SELF-FEEDING
POINT

Heavy Duty 30" Length Timber Auger Bits with 7/16" Quick Change Hex Shank are designed for use with pneumatic, electric and hydraulic drill motors and impact wrenches for drilling wooden railway cross ties, pressure treated lumber, creosoted poles, heavy timber, bulkheads, trees, etc... Double flute design with extended lip, double cutters, two outlining spurs, and a self-feeding screw point for boring clean holes. They are used by log home builders, arborists, railway maintenance departments, dock builders, utilities, etc...

SIZE	SHANK	ITEM NO.
9/16	7/16 Quick Change	TAB30L036
5/8	7/16 Quick Change	TAB30L040
11/16	7/16 Quick Change	TAB30L044
3/4	7/16 Quick Change	TAB30L048
13/16	7/16 Quick Change	TAB30L052
7/8	7/16 Quick Change	TAB30L056

SIZE	SHANK	ITEM NO.
15/16	7/16 Quick Change	TAB30L060
1	7/16 Quick Change	TAB30L100
1-1/16	7/16 Quick Change	TAB30L104
1-1/8	7/16 Quick Change	TAB30L108
1-1/2	7/16 Quick Change	TAB30L132

PREMIUM TOOL STEEL
TIMBER AUGER BITS - 40" LENGTH

ICS WIS

HEAVY DUTY

MEDIUM SCREW POINT

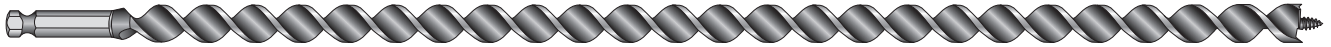

7/16"
QUICK CHANGE
HEX SHANK

40" Overall Length x 36" Double Flute Length

SELF-FEEDING
POINT

Heavy Duty 40" Length Timber Auger Bits with 7/16" Quick Change Hex Shank are designed for use with a standard rotary drill motor for drilling wooden railway cross ties, pressure treated lumber, creosoted poles, heavy timber, bulkheads, trees, etc... Double flute design with extended lip, double cutters, two outlining spurs, and a self-feeding screw point for boring clean holes. They are used by log home builders, arborists, railway maintenance departments, dock builders, utilities, etc...

SIZE	SHANK	ITEM NO.
9/16	7/16 Quick Change	TAB40L036
5/8	7/16 Quick Change	TAB40L040
11/16	7/16 Quick Change	TAB40L044
3/4	7/16 Quick Change	TAB40L048
13/16	7/16 Quick Change	TAB40L052

SIZE	SHANK	ITEM NO.
7/8	7/16 Quick Change	TAB40L056
15/16	7/16 Quick Change	TAB40L060
1	7/16 Quick Change	TAB40L100
1-1/16	7/16 Quick Change	TAB40L104
1-1/8	7/16 Quick Change	TAB40L108

TIMBER AUGER BITS - EXTENDED LENGTH

ICS WIS

SPECIAL PURPOSE

MEDIUM SCREW POINT

**QUICK RELEASE
HEX SHANK**



**SELF-FEEDING
POINT**

Heavy Duty 48", 60", & 72" Long Timber Auger Bits are used by contractors to build wooden retaining walls. They are manufactured 1/16" larger than the size of threaded rod being used to anchor wooden ties in place, e.g., a 3/4" threaded rod would use a 13/16" auger bit.

SIZE	SHANK	ITEM NO.
48" EXTENDED LENGTH		
9/16	7/16 Quick Change	TAB48L036
11/16	7/16 Quick Change	TAB48L044
60" EXTENDED LENGTH		
9/16	7/16 Quick Change	TAB60L036
11/16	7/16 Quick Change	TAB60L044
72" EXTENDED LENGTH		
9/16	7/16 Quick Change	TAB72L036
11/16	7/16 Quick Change	TAB72L044

SIZE	SHANK	ITEM NO.
48" EXTENDED LENGTH		
13/16	7/16 Quick Change	TAB48L052
15/16	7/16 Quick Change	TAB48L060
60" EXTENDED LENGTH		
13/16	7/16 Quick Change	TAB60L052
15/16	7/16 Quick Change	TAB60L060
72" EXTENDED LENGTH		
13/16	7/16 Quick Change	TAB72L052
15/16	7/16 Quick Change	TAB72L060

TOOL STEEL

POWER BIT EXTENSIONS

ICS WIS

GENERAL PURPOSE

PRECISION GROUND



Power Bit Extensions are for boring jobs requiring longer reach. Extensions can be connected to one another for extra long reach. Hex wrench included.

SIZE	LENGTH	FITS SHANK SIZE	FOLLOWS DRILL SIZE OF	ITEM NO.	PRICE
1/4	12	1/4 Hex / 5/16 Round	1/2" or larger	PBX016X12	11.08
1/4	18	1/4 Hex / 5/16 Round	1/2" or larger	PBX016X18	13.62
5/16	18	5/16 Hex / 3/8 Round	5/8" or larger	PBX020X18	15.30
5/16	24	5/16 Hex / 3/8 Round	5/8" or larger	PBX020X24	25.00
3/8	6	5/16 Hex / 3/8 Round	3/4" or larger	PBX024X06	16.80
3/8	12	5/16 Hex / 3/8 Round	3/4" or larger	PBX024X12	28.36
7/16	9-1/2	7/16 Hex / 1/2 Round	7/8" or larger	PBX028X09.5	21.00
7/16	12	7/16 Hex / 1/2 Round	7/8" or larger	PBX028X12	22.00
7/16	18	7/16 Hex / 1/2 Round	7/8" or larger	PBX028X18	25.00
7/16	24	7/16 Hex / 1/2 Round	7/8" or larger	PBX028X24	31.00

PREMIUM TOOL STEEL
SHIP AUGER BITS - 6" LENGTH

ICS WIS

HEAVY DUTY

MEDIUM SCREW POINT

QUICK RELEASE
HEX SHANK



SELF-FEEDING
POINT

6" O.A.L. x 4" FLUTE LENGTH

Heavy Duty 6" Long Ship Auger Bits are made of special tool steel. Machine ground hollows with deep open throat for fast chip removal. Ideal for heavy timbers and power poles. Single flute design with single cutter, side lip, and a self-feeding medium fast pitch screw point.

SIZE	HEX SHANK	ITEM NO.	PRICE
1/2	7/16	SAB06L032	18.14
9/16	7/16	SAB06L036	19.18
5/8	7/16	SAB06L040	19.18
11/16	7/16	SAB06L044	19.18
3/4	7/16	SAB06L048	19.18
13/16	7/16	SAB06L052	23.32
7/8	7/16	SAB06L056	23.32

SIZE	HEX SHANK	ITEM NO.	PRICE
15/16	7/16	SAB06L060	30.04
1	7/16	SAB06L100	30.04
1-1/8	7/16	SAB06L108	33.88
1-1/4	7/16	SAB06L116	38.38
1-3/8	7/16	SAB06L124	46.34
1-1/2	7/16	SAB06L132	50.32

PREMIUM TOOL STEEL
SHIP AUGER BITS - 8" LENGTH

ICS WIS

HEAVY DUTY

MEDIUM SCREW POINT

QUICK RELEASE
HEX SHANK



SELF-FEEDING
POINT

8" O.A.L. x 6" FLUTE LENGTH

Heavy Duty 8" Long Ship Auger Bits are made of premium tool steel. Machine ground hollows with deep open throat for fast chip removal. Ideal for heavy timbers and power poles. Single flute design with single cutter, side lip, and a self-feeding medium fast pitch screw point.

SIZE	HEX SHANK	ITEM NO.	PRICE
11/16	7/16	SAB08L044	26.12
3/4	7/16	SAB08L048	26.12
13/16	7/16	SAB08L052	31.48
7/8	7/16	SAB08L056	31.48
15/16	7/16	SAB08L060	39.94

SIZE	HEX SHANK	ITEM NO.	PRICE
1	7/16	SAB08L100	39.94
1-1/8	7/16	SAB08L108	45.44
1-1/4	7/16	SAB08L116	51.22
1-3/8	7/16	SAB08L124	61.40
1-1/2	7/16	SAB08L132	61.40

PREMIUM TOOL STEEL
SHIP AUGER BITS - 18" LENGTH

ICS WIS

HEAVY DUTY

MEDIUM SCREW POINT

QUICK RELEASE
HEX SHANK



SELF-FEEDING
POINT

18" O.A.L. x 15" FLUTE LENGTH

Heavy Duty 18" Long Ship Auger Bits are made of special tool steel. Machine ground hollows with deep open throat for fast chip removal. Ideal for heavy timbers and power poles. Single flute design with single cutter, side lip, and a self-feeding medium fast pitch screw point.

SIZE	HEX SHANK	ITEM NO.	PRICE
3/8	7/16	SAB18L024	22.64
7/16	7/16	SAB18L028	22.64
1/2	7/16	SAB18L032	23.84
9/16	7/16	SAB18L036	32.66
5/8	7/16	SAB18L040	32.66
11/16	7/16	SAB18L044	35.58
3/4	7/16	SAB18L048	35.58
13/16	7/16	SAB18L052	40.24

SIZE	HEX SHANK	ITEM NO.	PRICE
7/8	7/16	SAB18L056	40.24
15/16	7/16	SAB18L060	50.06
1	7/16	SAB18L100	50.06
1-1/16	7/16	SAB18L104	52.50
1-1/8	7/16	SAB18L108	58.64
1-1/4	7/16	SAB18L116	69.22
1-3/8	7/16	SAB18L124	75.44
1-1/2	7/16	SAB18L132	81.56

PREMIUM TOOL STEEL
SHIP AUGER BITS - EXTENDED LENGTH

ICS WIS

SPECIAL PURPOSE

MEDIUM SCREW POINT

QUICK RELEASE
HEX SHANK



SELF-FEEDING
POINT

Heavy Duty 48", 60", & 72" Long Ship Auger Bits are used by contractors to build wooden retaining walls. They are manufactured 1/16" larger than the size of threaded rod being used to anchor wooden ties in place, e.g., a 3/4" threaded rod would use a 13/16" auger bit.

SIZE	SHANK	ITEM NO.
48" EXTENDED LENGTH		
9/16	7/16 Quick Change	SAB48L036
11/16	7/16 Quick Change	SAB48L044
60" EXTENDED LENGTH		
9/16	7/16 Quick Change	SAB60L036
11/16	7/16 Quick Change	SAB60L044
72" EXTENDED LENGTH		
9/16	7/16 Quick Change	SAB72L036
11/16	7/16 Quick Change	SAB72L044

SIZE	SHANK	ITEM NO.
48" EXTENDED LENGTH		
13/16	7/16 Quick Change	SAB48L052
15/16	7/16 Quick Change	SAB48L060
60" EXTENDED LENGTH		
13/16	7/16 Quick Change	SAB60L052
15/16	7/16 Quick Change	SAB60L060
72" EXTENDED LENGTH		
13/16	7/16 Quick Change	SAB72L052
15/16	7/16 Quick Change	SAB72L060

HAND BRACE UTILITY POLE AUGER BITS

ICS WIS

GENERAL PURPOSE

MEDIUM SCREW POINT

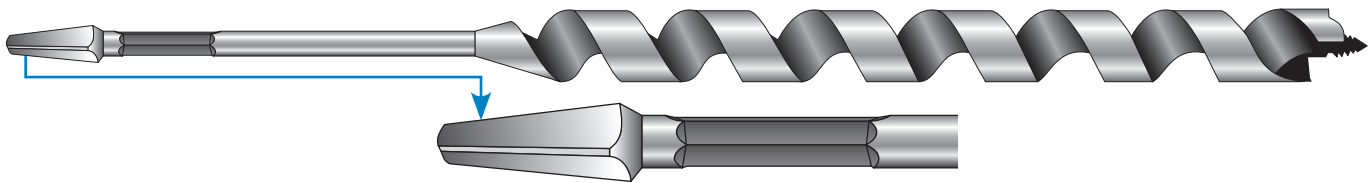

TAPER SQUARE SHANK HEX SHANK SECTION

Cutting off the the taper shank will convert it to a hex shank.

Hand Brace Utility Pole Auger Bits are designed for boring holes in creosoted poles, construction timber, and railroad ties without clogging, binding, or a need to stop to clear chips. Use in a hand brace or cut off the taper square shank for use in an electric drill. Single flute design with single cutter, side lip, and self feeding medium fast pitch screw point. Bits can be resharpened with an auger file.

SIZE	SHANK DIA.	SHANK TYPE	FLUTE LENGTH	OVERALL LENGTH	ITEM NO.	PRICE
3/8	3/8	TAPER SQUARE	12"	18"	HBAB-UP024	27.60
1/2	3/8	TAPER SQUARE	12"	18"	HBAB-UP032	29.12
9/16	3/8	TAPER SQUARE	12"	18"	HBAB-UP036	29.28
5/8	3/8	TAPER SQUARE	12"	18"	HBAB-UP040	29.54
3/4	5/16	ADAPTER HEX	12"	18"	HBAB-UP048	31.70
7/8	5/16	ADAPTER HEX	12"	18"	HBAB-UP056	36.28
1	5/16	ADAPTER HEX	12"	18"	HBAB-UP100	40.08

PREMIUM TOOL STEEL
POWER POLE BITS - 23" LENGTH

ICS WIS

SPECIAL PURPOSE

MEDIUM SCREW POINT

QUICK RELEASE
HEX SHANK



23" O.A.L. x 18" FLUTE LENGTH

SELF-FEEDING
POINT

Power Pole Bits are used to bore deep holes in creosoted poles, railroad ties, heavy timber, bulkheads, etc. Single flute design with single cutter, an outlining spur, side lip, and a self-feeding medium fast pitch screw point.

SIZE	HEX SHANK	ITEM NO.	PRICE
9/16	7/16	PPB23L036	45.96
5/8	7/16	PPB23L040	46.42
11/16	7/16	PPB23L044	50.12
3/4	7/16	PPB23L048	51.52

SIZE	HEX SHANK	ITEM NO.	PRICE
13/16	7/16	PPB23L052	54.56
7/8	7/16	PPB23L056	56.00
15/16	7/16	PPB23L060	60.06
1	7/16	PPB23L100	61.34

PREMIUM TOOL STEEL

IMPACT WRENCH (ELIMINATOR) AUGER BITS - 18" LENGTH

ICS WIS **HEAVY DUTY** **MEDIUM SCREW POINT**

QUICK RELEASE HEX SHANK  SELF-FEEDING POINT

18" O.A.L. x 15" FLUTE LENGTH

Impact Wrench Auger Bits are designed to bore holes in telephone or power line poles quickly using quick change chuck impact drills. Single flute design with single cutter, side lip, and a self-feeding medium fast pitch screw point.

SIZE	HEX SHANK	ITEM NO.	PRICE
9/16	7/16	IWAB18L036	40.36
11/16	7/16	IWAB18L044	42.84

SIZE	HEX SHANK	ITEM NO.	PRICE
13/16	7/16	IWAB18L052	46.58
15/16	7/16	IWAB18L060	49.14

CARBIDE TIPPED

IMPACT WRENCH (ELIMINATOR) AUGER BITS

ICS WIS **HEAVY DUTY** **MEDIUM SCREW POINT**

QUICK RELEASE HEX SHANK  SELF-FEEDING POINT

Carbide Tipped Impact Wrench Auger Bits are designed to bore holes into the hardest wood and creosoted poles used by utilities. They will outlast and outperform tool steel auger bits. Two sizes of shanks fit all impact wrenches with standard 7/16" or 5/8" hex adapters. Hex shank can also be used in 1/2" electric drill. Single flute design with double cutters, two outlining spurs, side lip, and a self-feeding medium fast pitch screw point. This bit is often referred to as The Eliminator.

7/16" SHANK

7/16" SHANK

5/8" SHANK

SIZE	ITEM NO.	PRICE
12" OAL x 9" Flute (7/16" Hex Shank)		
7/16	CTIWAB12L028	71.40
1/2	CTIWAB12L032	59.86
9/16	CTIWAB12L036	65.10
5/8	CTIWAB12L040	66.16
11/16	CTIWAB12L044	68.26
3/4	CTIWAB12L048	71.40
13/16	CTIWAB12L052	69.30
7/8	CTIWAB12L056	75.60
15/16	CTIWAB12L060	84.00
1	CTIWAB12L100	87.16
1-1/16	CTIWAB12L104	113.40
1-1/8	CTIWAB12L108	115.50
18" OAL x 15" Flute (7/16" Hex Shank)		
7/16	CTIWAB18L028	78.76
1/2	CTIWAB18L032	63.00
9/16	CTIWAB18L036	71.40
5/8	CTIWAB18L040	71.40
11/16	CTIWAB18L044	71.40
3/4	CTIWAB18L048	74.76
13/16	CTIWAB18L052	74.76
7/8	CTIWAB18L056	84.00
15/16	CTIWAB18L060	87.16
1	CTIWAB18L100	89.26
1-1/16	CTIWAB18L104	126.00
1-1/8	CTIWAB18L108	172.20
1-3/16	CTIWAB18L112	245.70
1-1/4	CTIWAB18L116	252.00

SIZE	ITEM NO.	PRICE
24" OAL x 21" Flute (7/16" Hex Shank)		
1/2	CTIWAB24L032	69.30
9/16	CTIWAB24L036	78.54
5/8	CTIWAB24L040	80.86
11/16	CTIWAB24L044	87.16
3/4	CTIWAB24L048	88.62
13/16	CTIWAB24L052	89.26
7/8	CTIWAB24L056	94.50
15/16	CTIWAB24L060	100.38
1	CTIWAB24L100	100.38
1-1/16	CTIWAB24L104	144.90
1-1/8	CTIWAB24L108	172.20
1-3/16	CTIWAB24L112	245.70
1-1/4	CTIWAB24L116	252.00
36" OAL x 33" Flute (7/16" Hex Shank)		
1/2	CTIWAB36L032	115.50
9/16	CTIWAB36L036	113.40
5/8	CTIWAB36L040	147.00
11/16	CTIWAB36L044	147.00
3/4	CTIWAB36L048	144.90
13/16	CTIWAB36L052	164.86
7/8	CTIWAB36L056	164.86
15/16	CTIWAB36L060	171.16
1	CTIWAB36L100	193.20
1-1/16	CTIWAB36L104	216.30
1-1/8	CTIWAB36L108	231.52
1-3/16	CTIWAB36L112	302.40
1-1/4	CTIWAB36L116	319.20
48" OAL x 45" Flute (7/16" Hex Shank)		
13/16	CTIWAB48L052	218.40
7/8	CTIWAB48L056	239.40
15/16	CTIWAB48L060	247.80
1	CTIWAB48L100	CALL
1-1/16	CTIWAB48L104	285.60
1-1/8	CTIWAB48L108	309.76
1-3/16	CTIWAB48L112	367.50
1-1/4	CTIWAB48L116	367.50

SIZE	ITEM NO.	PRICE
12" OAL x 9" Flute (5/8" Hex Shank)		
1/2	CTIWAB12L032A	59.86
9/16	CTIWAB12L036A	65.10
5/8	CTIWAB12L040A	66.16
11/16	CTIWAB12L044A	68.26
3/4	CTIWAB12L048A	71.40
13/16	CTIWAB12L052A	69.30
7/8	CTIWAB12L056A	75.60
15/16	CTIWAB12L060A	84.00
1	CTIWAB12L100A	87.16
1-1/16	CTIWAB12L104A	113.40
18" OAL x 15" Flute (5/8" Hex Shank)		
1/2	CTIWAB18L032A	63.00
9/16	CTIWAB18L036A	71.40
5/8	CTIWAB18L040A	71.40
11/16	CTIWAB18L044A	71.40
3/4	CTIWAB18L048A	74.76
13/16	CTIWAB18L052A	74.76
7/8	CTIWAB18L056A	84.00
15/16	CTIWAB18L060A	87.16
1	CTIWAB18L100A	89.26
1-1/16	CTIWAB18L104A	126.00
24" OAL x 21" Flute (5/8" Hex Shank)		
1/2	CTIWAB24L032A	69.30
9/16	CTIWAB24L036A	78.54
5/8	CTIWAB24L040A	80.86
11/16	CTIWAB24L044A	87.16
3/4	CTIWAB24L048A	88.62
13/16	CTIWAB24L052A	89.26
7/8	CTIWAB24L056A	94.50
15/16	CTIWAB24L060A	100.38
1	CTIWAB24L100A	100.38
1-1/16	CTIWAB24L104A	144.90

CARBIDE TIPPED
WOOD AUGER BITS - DOUBLE FLUTED

ICS WIS

SPECIAL PURPOSE

MEDIUM SCREW POINT

7/16" QUICK CHANGE
HEX SHANK



REPLACEABLE
SCREW POINT

Double Fluted Carbide Tipped Wood Auger Bits are designed with a heavy duty milled flute and a replaceable screw point to allow it to drill faster than conventional auger bits. Flutes are surface treated for corrosion resistance and fully heat treated to accept high torque load and guard against bit bending when using impact drills. They will drill precise holes in the hardest wood, creosoted poles, chipboard, and plywood. Also known as Double Spur Drills.

SIZE	SHANK	FLUTE LENGTH	OVERALL LENGTH	ITEM NO.	PRICE
9/16	7/16" Quick Change Hex Shank	8-9/16	12	CTWAB036X12	38.32
9/16	7/16" Quick Change Hex Shank	14-3/8	18	CTWAB036X18	41.26
11/16	7/16" Quick Change Hex Shank	8-9/16	12	CTWAB044X12	38.96
11/16	7/16" Quick Change Hex Shank	14-3/8	18	CTWAB044X18	42.00
13/16	7/16" Quick Change Hex Shank	8-9/16	12	CTWAB052X12	48.30
13/16	7/16" Quick Change Hex Shank	14-3/8	18	CTWAB052X18	52.08

HIGH SPEED STEEL
SCREW POINT PILOT AUGER DRILLS



High Speed Steel Replacement Screw Point Pilot Auger Drills are designed for use with Carbide Tipped Wood Auger Bits.

SIZE	FITS SIZES	STYLE	ITEM NO.	PRICE
3/8	3/8	SINGLE END	SPPAD024	5.26
1/2	1/2 - 9/16	SINGLE END	SPPAD032	5.26
5/8	5/8 - 13/16	SINGLE END	SPPAD040	5.26
7/8	7/8 - 1-1/8	SINGLE END	SPPAD056	5.26
1-1/4	1-1/4 - 1-1/2	SINGLE END	SPPAD116	5.26

CARBIDE TIPPED
WOOD AUGER BITS - DOUBLE FLUTED

ICS WIS

HEAVY DUTY

MEDIUM SCREW POINT

7/16" QUICK CHANGE
HEX SHANK

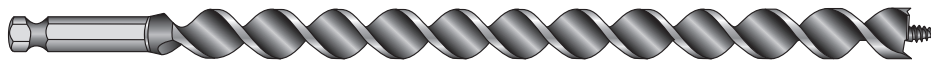

SELF FEEDING
POINT

Double Fluted Wood Auger Bits are designed with extended lip double cutters, two outlining spurs, and self-feeding screw point for boring clean, precise holes. They are for use with pneumatic, electric and hydraulic drill motors and impact wrenches for drilling wooden railway cross ties, pressure treated lumber, creosoted poles, heavy timber, bulk heads, trees etc... They are used by log home builders, arborists, railway maintenance departments, deck builders, utilities etc...

SIZE	SHANK	FLUTE LENGTH	OVERALL LENGTH	ITEM NO.	PRICE
1/2	7/16" Quick Change Hex Shank	15	18	WABDF032X18	20.62
9/16	7/16" Quick Change Hex Shank	15	18	WABDF036X18	24.60
11/16	7/16" Quick Change Hex Shank	15	18	WABDF044X18	31.30
13/16	7/16" Quick Change Hex Shank	15	18	WABDF052X18	49.02

IMPACT WRENCH AUGER BITS 1/2" FEMALE SQUARE SOCKET

ICS WIS

HEAVY DUTY

MEDIUM SCREW POINT

SQUARE SOCKET DRIVE



SELF-FEEDING POINT

18" OAL X 15" FLUTE LENGTH

1/2" Female Square Socket Impact Wrench Auger Bits are designed for general construction work using a 1/2" male square socket impact wrench. Single flute design with single cutter, side lip and a self-feeding medium fast pitch screw point.

SOCKET SIZE	FLUTE SIZE	FLUTE LENGTH	OVERALL LENGTH	ITEM NO.	PRICE
9/16	1/2	15	18	SSIWAB18L036	31.90
5/8	1/2	15	18	SSIWAB18L040	33.92
11/16	1/2	15	18	SSIWAB18L044	34.34
3/4	1/2	15	18	SSIWAB18L048	34.46

SOCKET SIZE	FLUTE SIZE	FLUTE LENGTH	OVERALL LENGTH	ITEM NO.	PRICE
13/16	1/2	15	18	SSIWAB18L052	37.96
7/8	1/2	15	18	SSIWAB18L056	37.96
15/16	1/2	15	18	SSIWAB18L060	39.86

SDS SHANK AUGER BITS

ICS WIS

HEAVY DUTY

MEDIUM SCREW POINT

4 SLOT SDS SHANK



SELF-FEEDING POINT

8" OAL X 6" FLUTE LENGTH

SDS Shank Auger Bits are designed for general construction work using any 4 slot drive systems. Single flute design with single cutter, side lip and a self-feeding medium fast pitch screw point. For rotary drilling only.

FLUTE SIZE	FLUTE LENGTH	OVERALL LENGTH	ITEM NO.	PRICE
1/4	6	8	AB-SDS016X08	4.70
5/16	6	8	AB-SDS020X08	4.70
3/8	6	8	AB-SDS024X08	5.08
7/16	6	8	AB-SDS028X08	5.20
1/2	6	8	AB-SDS032X08	5.34

FLUTE SIZE	FLUTE LENGTH	OVERALL LENGTH	ITEM NO.	PRICE
9/16	6	8	AB-SDS036X08	5.74
5/8	6	8	AB-SDS040X08	6.52
11/16	6	8	AB-SDS044X08	7.70
3/4	6	8	AB-SDS048X08	8.48

HAND DRIVE SCREW EYE AUGER BITS

ICS WIS

HEAVY DUTY

MEDIUM SCREW POINT

SCREW EYE DRIVE

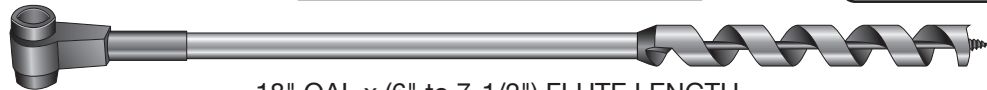

SELF-FEEDING POINT

18" OAL x (6" to 7-1/2") FLUTE LENGTH

Hand Drive Screw Eye Auger Bits are designed for boring holes in hardwoods where power is not available. An auger handle is put through the eye and the auger bit is turned by hand. Single flute design with single cutter, side lip and a large self-feeding point.

SIZE	OVERALL LENGTH	ITEM NO.	PRICE
5/16	18	AB-HD020X18	6.56
3/8	18	AB-HD024X18	7.06
7/16	18	AB-HD028X18	7.58
1/2	18	AB-HD032X18	7.58
9/16	18	AB-HD036X18	9.02

SIZE	OVERALL LENGTH	ITEM NO.	PRICE
5/8	18	AB-HD040X18	-
3/4	18	AB-HD048X18	10.08
7/8	18	AB-HD056X18	11.92
1	18	AB-HD100X18	13.72

HIGH SPEED STEEL RAILROAD TIE BORING BITS

ICS USA

SPECIAL PURPOSE

70° or 90° POINT

**ROUND OR
FLATTED SHANK**



**SINGLE
FLUTE**

High Speed Steel Single Flute Railroad Tie Boring Bits are specifically designed for drilling spike holes in railway cross ties. The single flute acts in a screw-like movement, feeding itself into the material for maximum chip removal. The open flute design prevents chip packing and reduces wood burning. Single flute drills are also known as Bobbin Bits.

SIZE	FLUTE LENGTH	OVERALL LENGTH	POINT ANGLE	SINGLE FLUTE	
				ROUND SHANK	FLATTED SHANK
9/16	6-3/8	9-3/8	70°	RTB1R036X09-70	RTB1F036-09-70
9/16	9-5/8	12-1/8	70°	RTB1R036X12-70	RTB1F036-12-70
5/8	6-3/8	9-3/8	70°	RTB1R040X09-70	RTB1F040-09-70
5/8	9-5/8	12-1/8	70°	RTB1R040X12-70	RTB1F040-12-70
11/16	6-3/8	9-3/8	70°	RTB1R044X09-70	RTB1F044-09-70
11/16	9-5/8	12-1/8	70°	RTB1R044X12-70	RTB1F044-12-70
3/4	6-3/8	9-3/8	70°	RTB1R048X09-70	RTB1F048-09-70
3/4	9-5/8	12-1/8	70°	RTB1R048X12-70	RTB1F048-12-70
9/16	6-3/8	9-3/8	90°	RTB1R036X09-90	RTB1F036-09-90
9/16	9-5/8	12-1/8	90°	RTB1R036X12-90	RTB1F036-12-90
5/8	6-3/8	9-3/8	90°	RTB1R040X09-90	RTB1F040-09-90
5/8	9-5/8	12-1/8	90°	RTB1R040X12-90	RTB1F040-12-90
11/16	6-3/8	9-3/8	90°	RTB1R044X09-90	RTB1F044-09-90
11/16	9-5/8	12-1/8	90°	RTB1R044X12-90	RTB1F044-12-90
3/4	6-3/8	9-3/8	90°	RTB1R048X09-90	RTB1F048-09-90
3/4	9-5/8	12-1/8	90°	RTB1R048X12-90	RTB1F048-12-90

HIGH SPEED STEEL RAILROAD TIE BORING BITS

ICS USA

SPECIAL PURPOSE

70° or 90° POINT

**ROUND OR
FLATTED SHANK**



**TWO
FLUTE**

High Speed Steel Two Flute Railroad Tie Boring Bits are specifically designed for drilling holes in railway cross ties. The double flute design combines ease of penetration with rapid chip removal in deep hole, hardwood drilling.

SIZE	FLUTE LENGTH	OVERALL LENGTH	POINT ANGLE	TWO FLUTE	
				ROUND SHANK	FLATTED SHANK
9/16	6-3/8	9-3/8	70°	RTB2R036X09-70	RTB2F036-09-70
9/16	9-5/8	12-1/8	70°	RTB2R036X12-70	RTB2F036-12-70
5/8	6-3/8	9-3/8	70°	RTB2R040X09-70	RTB2F040-09-70
5/8	9-5/8	12-1/8	70°	RTB2R040X12-70	RTB2F040-12-70
11/16	6-3/8	9-3/8	70°	RTB2R044X09-70	RTB2F044-09-70
11/16	9-5/8	12-1/8	70°	RTB2R044X12-70	RTB2F044-12-70
3/4	6-3/8	9-3/8	70°	RTB2R048X09-70	RTB2F048-09-70
3/4	9-5/8	12-1/8	70°	RTB2R048X12-70	RTB2F048-12-70
9/16	6-3/8	9-3/8	90°	RTB2R036X09-90	RTB2F036-09-90
9/16	9-5/8	12-1/8	90°	RTB2R036X12-90	RTB2F036-12-90
5/8	6-3/8	9-3/8	90°	RTB2R040X09-90	RTB2F040-09-90
5/8	9-5/8	12-1/8	90°	RTB2R040X12-90	RTB2F040-12-90
11/16	6-3/8	9-3/8	90°	RTB2R044X09-90	RTB2F044-09-90
11/16	9-5/8	12-1/8	90°	RTB2R044X12-90	RTB2F044-12-90
3/4	6-3/8	9-3/8	90°	RTB2R048X09-90	RTB2F048-09-90
3/4	9-5/8	12-1/8	90°	RTB2R048X12-90	RTB2F048-12-90

CARBIDE TIPPED TRI POINT AUGER BITS

ICS WIS

HEAVY DUTY

TRI POINT

1/2" ROUND SHANK



Carbide Tipped Tri Point Auger Bits are designed for CNC machines to do pre plate drilling of railway cross ties.

SIZE	LENGTH	SHANK	ITEM NO.	PRICE
5/8	12	1/2	CTTPAB040X12	47.50
11/16	12	1/2	CTTPAB044X12	49.00
3/4	12	1/2	CTTPAB048X12	50.96
METRIC				
18mm	12	1/2	CTTPABM18X12	52.00

HIGH SPEED STEEL MORTISE BITS BI-DIRECTIONAL

ICS WIS

SPECIAL PURPOSE

STRAIGHT OR 1/2" SHANK



RIGHT OR LEFT HAND CUTTING

High Speed Steel Bi-Directional Mortise Bits are designed with two flutes for right and left hand cutting. They are used in Rye oscillating mortising machines to produce clean slots by oscillating cutting strokes. They are also known as Reciprocating Slotters, Oscillating Mortise Bits, Mortising Router Bits, Multi-Directional Mortise Cutters or Bird's Mouth Mortising Bits.

CUTTING DIAMETER	CUTTING LENGTH	SHANK DIAMETER	OVERALL LENGTH	ITEM NO.	PRICE
1/4	2	1/4	4	MBBDSS016X200	12.60
5/16	2	5/16	4	MBBDSS020X200	12.60
3/8	2-1/2	3/8	4-1/2	MBBDSS024X232	13.54
7/16	2-1/2	7/16	4-1/2	MBBDSS028X232	16.92
1/2" SHANK					
1/4	1-1/4	1/2	3-1/4	MBBDRS016X116	12.60
1/4	2	1/2	4-1/2	MBBDRS016X200	12.60
5/16	2	1/2	4-1/2	MBBDRS020X200	12.60
3/8	2	1/2	4-1/2	MBBDRS024X200	12.60
1/2	2-1/2	1/2	4-1/2	MBBDRS032X232	12.60

HIGH SPEED STEEL KEYHOLE SLOT ROUTER BIT

ICS WIS

SPECIAL PURPOSE

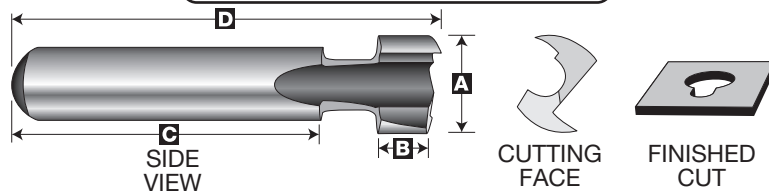

High Speed Steel Keyhole Slot Router Bits are designed to rout a vertical or horizontal keyhole slot for hanging picture frames, shelves, mirrors, plaques, clocks, candle sconces, cabinets, support fixtures, and other wall hangings. They cut a 5/16" or 3/8" entry hole and recessed slot for positive hanging on a headed fastener.

CUTTING DIAMETER "A"	CUTTING LENGTH "B"	SHANK LENGTH "C"	OVERALL LENGTH "D"	SHANK DIAMETER	ITEM NO.	PRICE
5/16	11/64	1	1-3/8	1/8	RB-KHC020	7.88
3/8	13/64	1	1-3/8	1/4	RB-KHC024	10.50

**HIGH SPEED STEEL
VIX BITS**

ICS WIS

SPECIAL PURPOSE

118° POINT

1/4" HEX SHANK
QUICK CHANGE

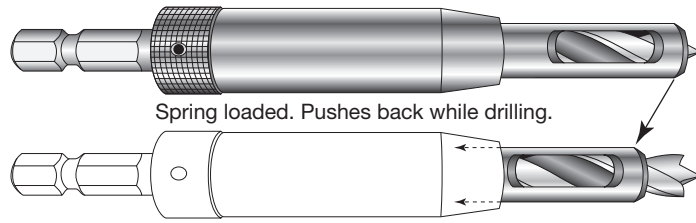

RIGHT
HAND CUT

High Speed Steel Hex Shank Self Centering Vix Bits are designed for accurately centering and drilling screw holes for hinges, striker plates, door butts, window pulls, and all cabinet hardware using screws.

DRILL SIZE	FOR SCREW SIZES	DRILL POINT	ITEM NO.	PRICE
5/64	#3, #4	118° Point	VB005	13.58
7/64	#5, #6	118° Point	VB007	13.58
9/64	#8, #9, #10	118° Point	VB009	13.58
11/64	#12	118° Point	VB011	15.16
13/64	#14	118° Point	VB013	15.16
1/4	Shelf Pin	Brad Point	VB016	15.16
METRIC				
5.0mm	Shelf Pin	Brad Point	VBM05.0	15.16

**TOOL STEEL
BORING CHUCKS**

ICS WIS

SPECIAL PURPOSE

PRECISION CRAFTED

7/16" - 14
THREADS

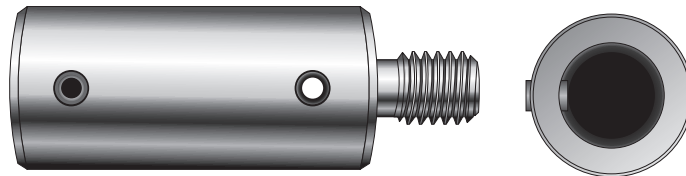

RIGHT
HAND CUT

Boring Chucks are designed for use in machines requiring a 7/16"-14 threaded shank. They accept straight shank drills and are held in place with set screw(s). Each chuck has a 3/16" or 1/4" hole through the body to tighten the threaded shank into the drilling machine holder. They are also known as Adapter Chucks and are compatible with Morris Adapter Chucks (style 1) and Forrest City Boring Chucks (#5).

DRILL SIZE	OUTSIDE DIAMETER	OVERALL LENGTH	ROTATION DIRECTION	ITEM NO.	PRICE
1/8	5/8	1-1/2	RIGHT	BCRH008	16.80
5/32	5/8	1-1/2	RIGHT	BCRH010	16.80
3/16	5/8	1-1/2	RIGHT	BCRH012	16.80
7/32	5/8	1-1/2	RIGHT	BCRH014	16.80
1/4	5/8	1-1/2	RIGHT	BCRH016	16.80
9/32	5/8	1-1/2	RIGHT	BCRH018	16.80
5/16	7/8	1-3/4	RIGHT	BCRH020	19.96
3/8	7/8	1-3/4	RIGHT	BCRH024	19.96
7/16	7/8	1-3/4	RIGHT	BCRH028	19.96
1/2	7/8	1-3/4	RIGHT	BCRH032	19.96
METRIC					
M10.00	7/8	1-3/4	RIGHT	BCRHM10.0	19.96

CARBIDE TIPPED FIBERGLASS HOLLOW CORE BITS

ICS WIS
SPECIAL PURPOSE
90° POINT
**QUICK RELEASE
7/16" HEX SHANK**
**GROUND
SHORT FLUTE**

Carbide Tipped Fiberglass Hollow Core Bits are designed for drilling through hollow core utility poles made from fiberglass and/or composite materials. They are manufactured with a ground short flute and no clearance to create a rigid solid round body to support the drill on center through initial entry hole and opposite side wall without damaging the entry hole.

SIZE	FLUTE	OAL	ITEM NO.	PRICE
1/2	6	12	CTFGHCB032X12	46.76
1/2	6	18	CTFGHCB032X18	49.90
1/2	6	24	CTFGHCB032X24	53.76
9/16	6	12	CTFGHCB036X12	49.62
9/16	6	18	CTFGHCB036X18	55.02
9/16	6	24	CTFGHCB036X24	59.56
5/8	6	12	CTFGHCB040X12	52.46
5/8	6	18	CTFGHCB040X18	58.60
5/8	6	24	CTFGHCB040X24	61.34
11/16	6	12	CTFGHCB044X12	54.94
11/16	6	18	CTFGHCB044X18	60.90
11/16	6	24	CTFGHCB044X24	70.26
3/4	6	12	CTFGHCB048X12	58.84
3/4	6	18	CTFGHCB048X18	63.90
3/4	6	24	CTFGHCB048X24	74.22
13/16	6	12	CTFGHCB052X12	62.12
13/16	6	18	CTFGHCB052X18	69.10

SIZE	FLUTE	OAL	ITEM NO.	PRICE
13/16	6	24	CTFGHCB052X24	76.78
7/8	6	12	CTFGHCB056X12	71.66
7/8	6	18	CTFGHCB056X18	78.88
7/8	6	24	CTFGHCB056X24	94.40
15/16	6	12	CTFGHCB060X12	81.34
15/16	6	18	CTFGHCB060X18	86.84
15/16	6	24	CTFGHCB060X24	89.34
1	6	12	CTFGHCB100X12	84.40
1	6	18	CTFGHCB100X18	91.84
1	6	24	CTFGHCB100X24	102.40
1-1/16	6	12	CTFGHCB104X12	89.34
1-1/16	6	18	CTFGHCB104X18	95.94
1-1/16	6	24	CTFGHCB104X24	102.40
1-1/8	6	12	CTFGHCB108X12	94.72
1-1/8	6	18	CTFGHCB108X18	102.40
1-1/8	6	24	CTFGHCB108X24	108.74

CARBIDE TIPPED FIBERGLASS SOLID CORE BITS

ICS WIS
SPECIAL PURPOSE
90° POINT
**QUICK RELEASE
7/16" HEX SHANK**
**GROUND
SHORT FLUTE**

Carbide Tipped Fiberglass Solid Core Bits are designed for drilling solid/foam core utility poles and cross arms made from fiberglass, resin and composite materials. They are manufactured with full flute and solid body to be able to drill through fiberglass/resin/composite poles. The full fluting allows bit to remove debris from the hole without melting it.

SIZE	FLUTE	OAL	ITEM NO.	PRICE
1/2	9	12	CTFGSCB032X12	57.02
1/2	15	18	CTFGSCB032X18	59.70
1/2	21	24	CTFGSCB032X24	64.04
9/16	9	12	CTFGSCB036X12	58.42
9/16	15	18	CTFGSCB036X18	64.34
9/16	21	24	CTFGSCB036X24	73.12
5/8	9	12	CTFGSCB040X12	60.92
5/8	15	18	CTFGSCB040X18	73.06
5/8	21	24	CTFGSCB040X24	76.78
11/16	9	12	CTFGSCB044X12	64.34
11/16	15	18	CTFGSCB044X18	73.00
11/16	21	24	CTFGSCB044X24	80.38
3/4	9	12	CTFGSCB048X12	67.02
3/4	15	18	CTFGSCB048X18	73.12
3/4	21	24	CTFGSCB048X24	82.88
13/16	9	12	CTFGSCB052X12	71.84
13/16	15	18	CTFGSCB052X18	79.22

SIZE	FLUTE	OAL	ITEM NO.	PRICE
13/16	21	24	CTFGSCB052X24	85.32
7/8	9	12	CTFGSCB056X12	85.08
7/8	15	18	CTFGSCB056X18	90.14
7/8	21	24	CTFGSCB056X24	99.96
15/16	9	12	CTFGSCB060X12	87.22
15/16	15	18	CTFGSCB060X18	94.96
15/16	21	24	CTFGSCB060X24	102.28
1	9	12	CTFGSCB100X12	89.66
1	15	18	CTFGSCB100X18	97.46
1	21	24	CTFGSCB100X24	109.72
1-1/16	9	12	CTFGSCB104X12	97.46
1-1/16	15	18	CTFGSCB104X18	103.08
1-1/16	21	24	CTFGSCB104X24	115.82
1-1/8	9	12	CTFGSCB108X12	99.78
1-1/8	15	18	CTFGSCB108X18	104.84
1-1/8	21	24	CTFGSCB108X24	118.20

ICS Cutting Tools, Inc.



SCAN FOR LATEST ONLINE CATALOGS



SCAN TO OPEN THE WEBSITE

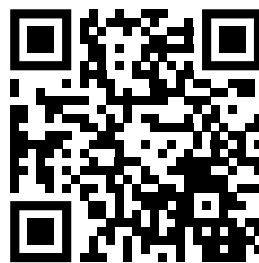

ICS CUTTING TOOLS, INC
511 MAIN STREET • CASCO, WI 54205-0125 USA

(920) 837-2526 • FAX (920) 837-2530
www.icscuttingtools.com • info@icscuttingtools.com